

## Features

- Low-voltage and Standard-voltage Operation
  - 1.8 (V<sub>CC</sub> = 1.8V to 5.5V)
- Internally Organized 512 x 8 (4K), or 1024 x 8 (8K)
- Two-wire Serial Interface
- Schmitt Trigger, Filtered Inputs for Noise Suppression
- Bidirectional Data Transfer Protocol
- 1 MHz (5V), 400 kHz (1.8V, 2.5V, 2.7V) Compatibility
- Write Protect Pin for Hardware Data Protection
- 16-byte Page (4K, 8K) Write Modes
- Partial Page Writes Allowed
- Self-timed Write Cycle (5 ms max)
- High-reliability
  - Endurance: 1 Million Write Cycles
  - Data Retention: 100 Years
- 8-lead PDIP, 8-lead JEDEC SOIC, 8-lead Ultra-Thin Mini-MAP (MLP 2x3), 5-lead SOT23, 8-lead TSSOP and 8-ball dBGAs Packages
- Lead-free/Halogen-free
- Die Sales: Wafer Form, Tape and Reel and Bumped Wafers

## Description

The AT24C04B/08B provides 4096/8192 bits of serial electrically erasable and programmable read-only memory (EEPROM) organized as 512/1024 words of 8 bits each. The device is optimized for use in many industrial and commercial applications where low-power and low-voltage operation are essential. The AT24C04B/08B is available in space-saving 8-lead PDIP, 8-lead JEDEC SOIC, 8-lead Ultra-Thin Mini-MAP (MLP 2x3), 5-lead SOT23, 8-lead TSSOP, and 8-ball dBGAs packages and is accessed via a Two-wire serial interface. In addition, the AT24C04B/08B is available in 1.8V (1.8V to 5.5V) version.

**Table 0-1.** Pin Configuration

Pin Name	Function
A0 - A2	Address Inputs
SDA	Serial Data
SCL	Serial Clock Input
WP	Write Protect
NC	No Connect
GND	Ground
VCC	Power Supply

Note: For use of 5-lead SOT23

4K: The software A2 and A1 bits in the device address word must be set to zero to properly communicate.

8K: The software A2 bit in the device address word must be set to zero to properly communicate.

8-lead Ultra-Thin Mini-MAP (MLP 2x3)

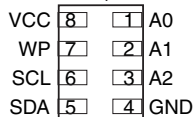

Bottom View

8-ball dBGAs

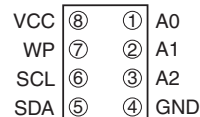

Bottom View

8-lead TSSOP

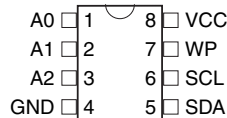

8-lead SOIC

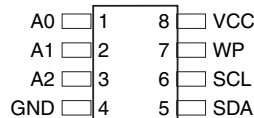

5-lead SOT23

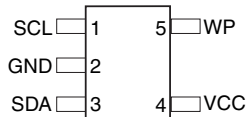

8-lead PDIP

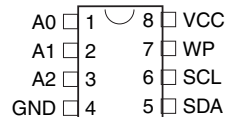

## Two-wire Serial EEPROM

4K (512 x 8)

8K (1024 x 8)

**AT24C04B**

**AT24C08B**



## Absolute Maximum Ratings

Operating Temperature .....	-55°C to +125°C
Storage Temperature .....	-65°C to +150°C
Voltage on Any Pin with Respect to Ground .....	-1.0V to +7.0V
Maximum Operating Voltage .....	6.25V
DC Output Current.....	5.0 mA

**\*NOTICE:** Stresses beyond those listed under “Absolute Maximum Ratings” may cause permanent damage to the device. This is a stress rating only and functional operation of the device at these or any other conditions beyond those indicated in the operational sections of this specification is not implied. Exposure to absolute maximum rating conditions for extended periods may affect device reliability.

**Figure 0-1.** Block Diagram

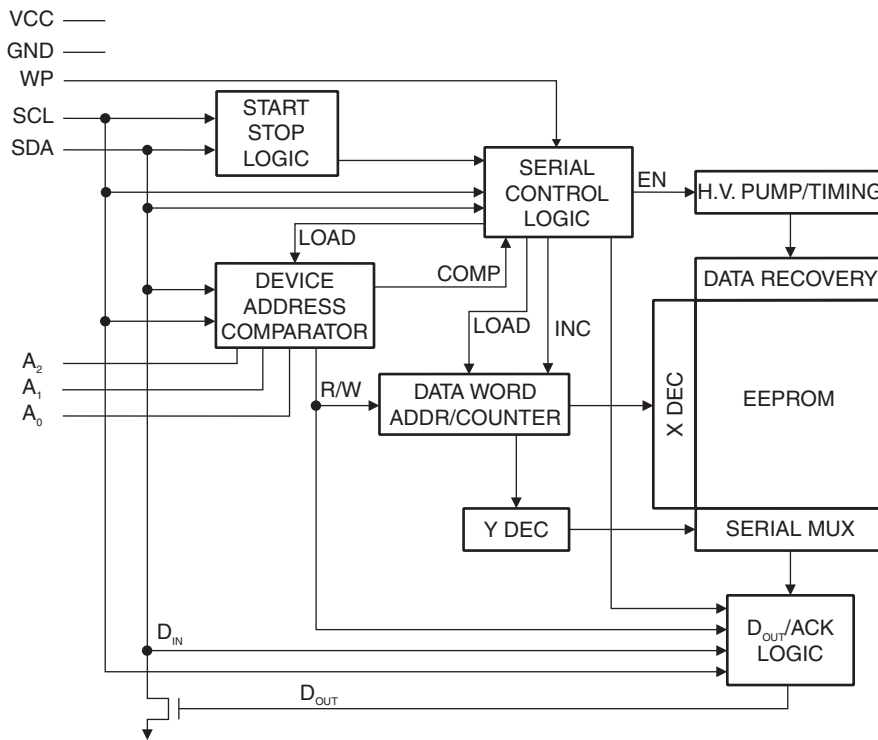

## 1. Pin Description

**SERIAL CLOCK (SCL):** The SCL input is used to positive edge clock data into each EEPROM device and negative edge clock data out of each device.

**SERIAL DATA (SDA):** The SDA pin is bidirectional for serial data transfer. This pin is open-drain driven and may be wire-ORed with any number of other open-drain or open-collector devices.

### **DEVICE/PAGE ADDRESSES (A2, A1, A0):**

The AT24C04B uses the A2 and A1 inputs for hard wire addressing and a total of four 4K devices may be addressed on a single bus system. The A0 pin is a no connect and can be connected to ground (device addressing is discussed in detail under the Device Addressing section).

The AT24C08B only uses the A2 input for hardware addressing and a total of two 8K devices may be addressed on a single bus system. The A0 and A1 pins are no connects and can be connected to ground (device addressing is discussed in detail under the Device Addressing section).

**Table 1-1. Write Protect**

WP Pin Status	Part of the Array Protected
	24C04B/08B
At V <sub>CC</sub>	Full Array
At GND	Normal Read/Write Operations



## 2. Memory Organization

**AT24C04B, 4K SERIAL EEPROM:** Internally organized with 32 pages of 16 bytes each, the 4K requires an 9-bit data word address for random word addressing.

**AT24C08B, 8K SERIAL EEPROM:** Internally organized with 64 pages of 16 bytes each, the 8K requires a 10-bit data word address for random word addressing.

**Table 2-1.** Pin Capacitance<sup>(1)</sup>

Applicable over recommended operating range from  $T_A = 25^\circ\text{C}$ ,  $f = 1.0\text{ MHz}$ ,  $V_{CC} = +1.8\text{V}$

Symbol	Test Condition	Max	Units	Conditions
$C_{I/O}$	Input/Output Capacitance (SDA)	8	pF	$V_{I/O} = 0\text{V}$
$C_{IN}$	Input Capacitance ( $A_0, A_1, A_2, \text{SCL}$ )	6	pF	$V_{IN} = 0\text{V}$

Note: 1. This parameter is characterized and is not 100% tested.

**Table 2-2.** DC Characteristics

Applicable over recommended operating range from:  $T_{AI} = -40^\circ\text{C}$  to  $+85^\circ\text{C}$ ,  $V_{CC} = +1.8\text{V}$  to  $+5.5\text{V}$ , (unless otherwise noted)

Symbol	Parameter	Test Condition	Min	Typ	Max	Units
$V_{CC1}$	Supply Voltage		1.8		5.5	V
$V_{CC2}$	Supply Voltage		2.5		5.5	V
$V_{CC3}$	Supply Voltage		2.7		5.5	V
$V_{CC4}$	Supply Voltage		4.5		5.5	V
$I_{CC}$	Supply Current $V_{CC} = 5.0\text{V}$	READ at 100 kHz		0.4	1.0	mA
$I_{CC}$	Supply Current $V_{CC} = 5.0\text{V}$	WRITE at 100 kHz		2.0	3.0	mA
$I_{SB1}$	Standby Current $V_{CC} = 1.8\text{V}$	$V_{IN} = V_{CC}$ or $V_{SS}$		0.6	3.0	$\mu\text{A}$
$I_{SB2}$	Standby Current $V_{CC} = 2.5\text{V}$	$V_{IN} = V_{CC}$ or $V_{SS}$		1.4	4.0	$\mu\text{A}$
$I_{SB3}$	Standby Current $V_{CC} = 2.7\text{V}$	$V_{IN} = V_{CC}$ or $V_{SS}$		1.6	4.0	$\mu\text{A}$
$I_{SB4}$	Standby Current $V_{CC} = 5.0\text{V}$	$V_{IN} = V_{CC}$ or $V_{SS}$		8.0	18.0	$\mu\text{A}$
$I_{LI}$	Input Leakage Current	$V_{IN} = V_{CC}$ or $V_{SS}$		0.10	3.0	$\mu\text{A}$
$I_{LO}$	Output Leakage Current	$V_{OUT} = V_{CC}$ or $V_{SS}$		0.05	3.0	$\mu\text{A}$
$V_{IL}$	Input Low Level <sup>(1)</sup>		-0.6		$V_{CC} \times 0.3$	V
$V_{IH}$	Input High Level <sup>(1)</sup>		$V_{CC} \times 0.7$		$V_{CC} + 0.5$	V
$V_{OL2}$	Output Low Level $V_{CC} = 3.0\text{V}$	$I_{OL} = 2.1\text{ mA}$			0.4	V
$V_{OL1}$	Output Low Level $V_{CC} = 1.8\text{V}$	$I_{OL} = 0.15\text{ mA}$			0.2	V

Note: 1.  $V_{IL}$  min and  $V_{IH}$  max are reference only and are not tested.

**Table 2-3.** AC Characteristics

Applicable over recommended operating range from  $T_{AI} = -40^{\circ}\text{C}$  to  $+85^{\circ}\text{C}$ ,  $V_{CC} = +1.8\text{V}$  to  $+5.5\text{V}$ ,  $CL = 1$  TTL Gate and  $100$  pF (unless otherwise noted)

Symbol	Parameter	1.8, 2.5, 2.7		5.0-volt		Units
		Min	Max	Min	Max	
$f_{SCL}$	Clock Frequency, SCL		400		1000	kHz
$t_{LOW}$	Clock Pulse Width Low	1.2		0.4		$\mu\text{s}$
$t_{HIGH}$	Clock Pulse Width High	0.6		0.4		$\mu\text{s}$
$t_I$	Noise Suppression Time		50		40	ns
$t_{AA}$	Clock Low to Data Out Valid	0.1	0.9	0.05	0.55	$\mu\text{s}$
$t_{BUF}$	Time the bus must be free before a new transmission can start	1.2		0.5		$\mu\text{s}$
$t_{HD.STA}$	Start Hold Time	0.6		0.25		$\mu\text{s}$
$t_{SU.STA}$	Start Setup Time	0.6		0.25		$\mu\text{s}$
$t_{HD.DAT}$	Data In Hold Time	0		0		$\mu\text{s}$
$t_{SU.DAT}$	Data In Setup Time	100		100		ns
$t_R$	Inputs Rise Time <sup>(1)</sup>		0.3		0.3	$\mu\text{s}$
$t_F$	Inputs Fall Time <sup>(1)</sup>		300		100	ns
$t_{SU.STO}$	Stop Setup Time	0.6		.25		$\mu\text{s}$
$t_{DH}$	Data Out Hold Time	50		50		ns
$t_{WR}$	Write Cycle Time		5		5	ms
Endurance <sup>(1)</sup>	5.0V, 25°C, Byte Mode	1M		1M		Write Cycles

Note: 1. This parameter is ensured by characterization only.

### 3. Device Operation

**CLOCK and DATA TRANSITIONS:** The SDA pin is normally pulled high with an external device. Data on the SDA pin may change only during SCL low time periods (see [Figure 5-2 on page 8](#)). Data changes during SCL high periods will indicate a start or stop condition as defined below.

**START CONDITION:** A high-to-low transition of SDA with SCL high is a start condition which must precede any other command (see [Figure 5-3 on page 8](#)).

**STOP CONDITION:** A low-to-high transition of SDA with SCL high is a stop condition. After a read sequence, the stop command will place the EEPROM in a standby power mode (see [Figure 5-3 on page 8](#)).

**ACKNOWLEDGE:** All addresses and data words are serially transmitted to and from the EEPROM in 8-bit words. The EEPROM sends a zero to acknowledge that it has received each word. This happens during the ninth clock cycle.

**STANDBY MODE:** The AT24C04B/08B features a low-power standby mode which is enabled: (a) upon power-up and (b) after the receipt of the STOP bit and the completion of any internal operations.

**2-WIRE SOFTWARE RESET:** After an interruption in protocol, power loss or system reset, any 2-wire part can be reset by following these steps: (a) Create a start bit condition, (b) clock 9 cycles, (c) create another start bit followed by a stop bit condition as shown below. The device is ready for next communication after above steps have been completed.

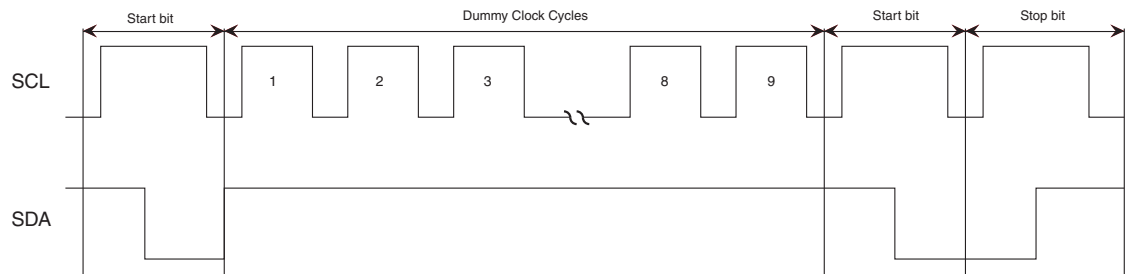

## 4. Bus Timing

Figure 4-1. SCL: Serial Clock, SDA: Serial Data I/O®

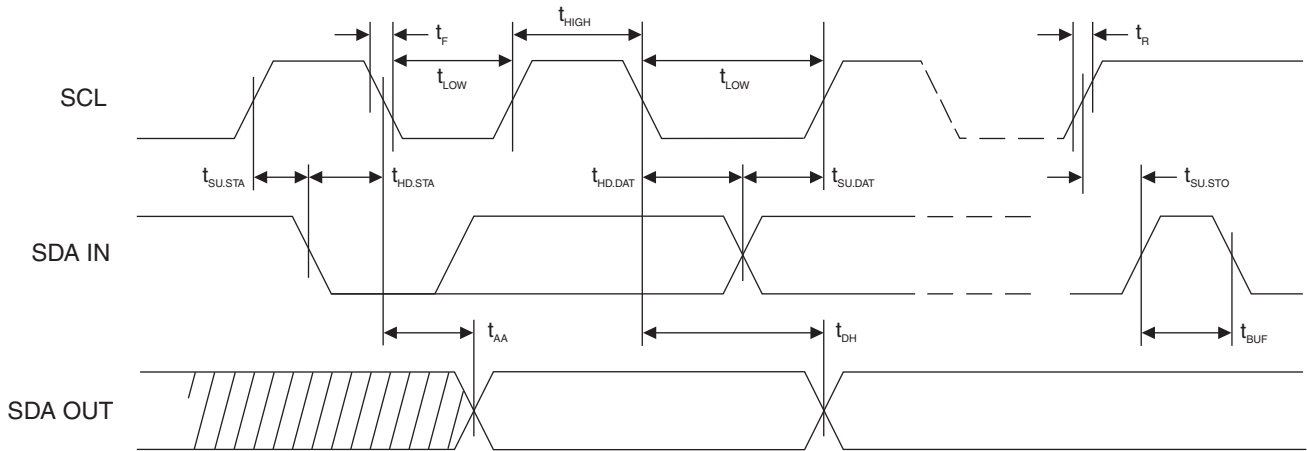

## 5. Write Cycle Timing

Figure 5-1. SCL: Serial Clock, SDA: Serial Data I/O

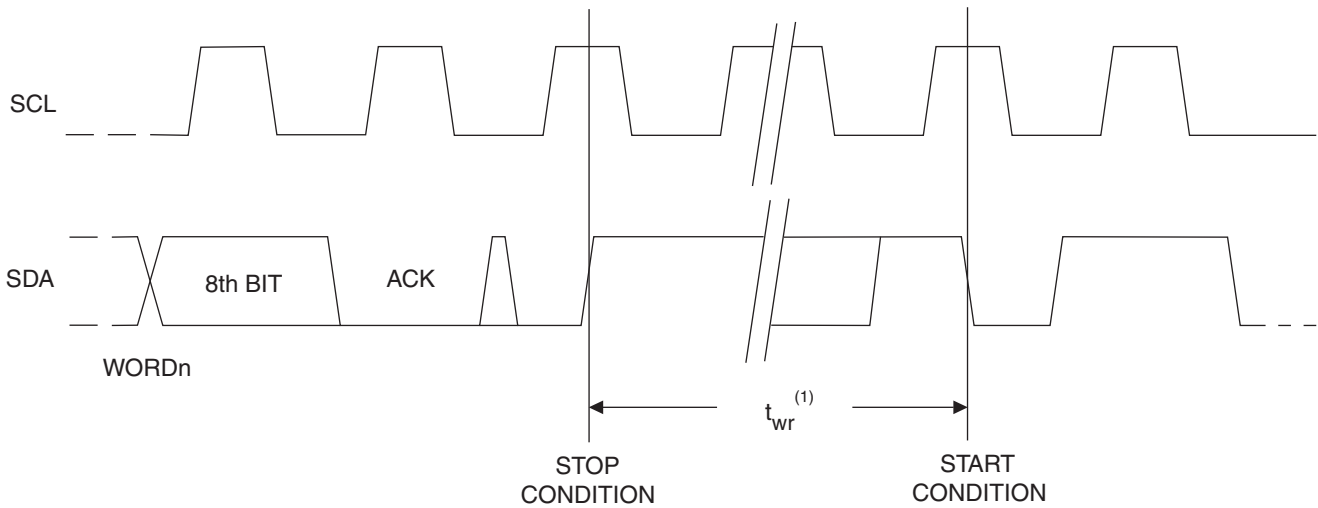

Note: 1. The write cycle time  $t_{WR}$  is the time from a valid stop condition of a write sequence to the end of the internal clear/write cycle.

**Figure 5-2.** Data Validity

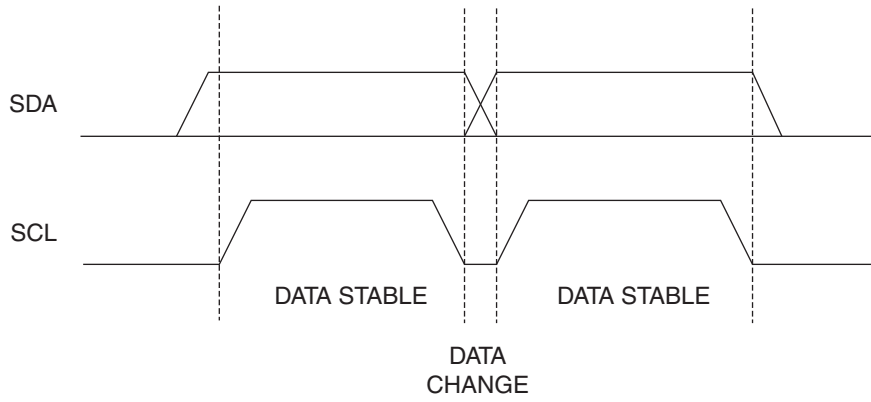

**Figure 5-3.** Start and Stop Definition

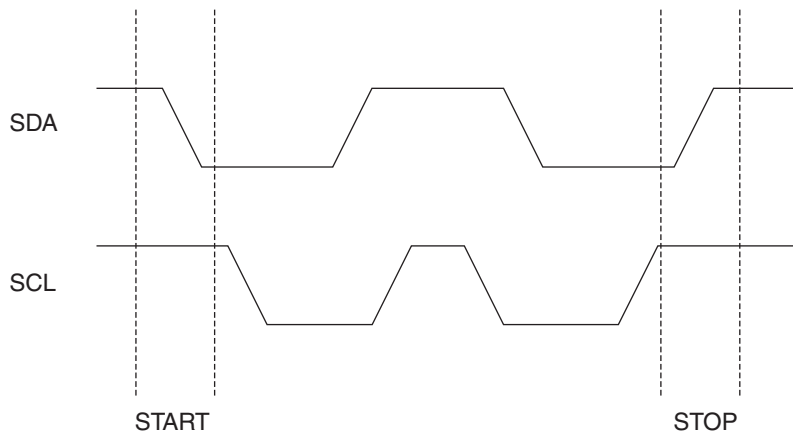

**Figure 5-4.** Output Acknowledge

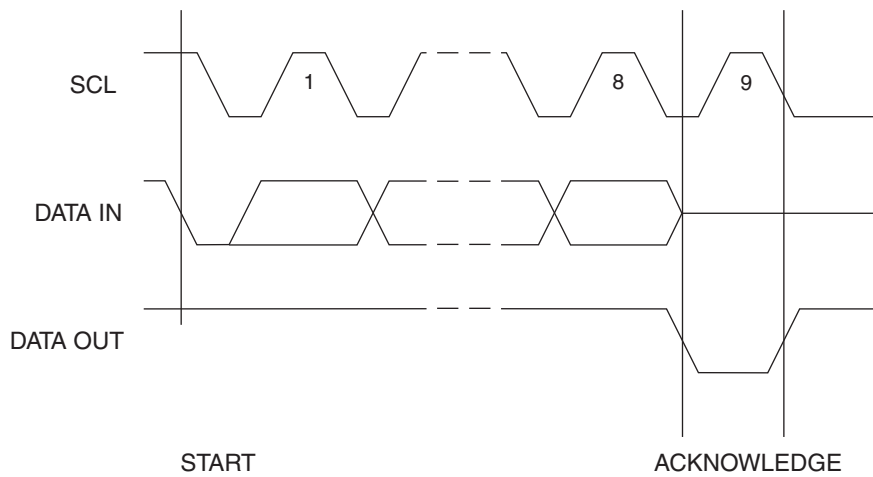



## 6. Device Addressing

The 4K and 8K EEPROM device requires an 8-bit device address word following a start condition to enable the chip for a read or write operation (refer to [Figure 8-1](#)).

The device address word consists of a mandatory one, zero sequence for the first four most significant bits as shown. This is common to all the EEPROM devices.

The 4K EEPROM only uses the A2 and A1 device address bits with the third bit being a memory page address bit. The two device address bits must compare to their corresponding hard-wired input pins. The A0 pin is no connect.

The 8K EEPROM only uses the A2 device address bit with the next 2 bits being for memory page addressing. The A2 must compare to its corresponding hard-wired input pin. The A1 and A0 pins are no connect.

For the SOT23 Package Offering:

The 4K EEPROM software A2 and A1 bits in the device address word must be set to zero to properly communicate.

The 8K EEPROM software A2 bit in the device address word must be set to zero to properly communicate.

## 7. Write Operations

**BYTE WRITE:** A write operation requires an 8-bit data word address following the device address word and acknowledgment. Upon receipt of this address, the EEPROM will again respond with a zero and then clock in the first 8-bit data word. Following receipt of the 8-bit data word, the EEPROM will output a zero and the addressing device, such as a microcontroller, must terminate the write sequence with a stop condition. At this time the EEPROM enters an internally timed write cycle,  $t_{WR}$ , to the nonvolatile memory. All inputs are disabled during this write cycle and the EEPROM will not respond until the write is complete (see [Figure 8-2 on page 11](#)).

**PAGE WRITE:** The 4K/8K EEPROMs are capable of 16-byte page writes.

A page write is initiated the same as a byte write, but the microcontroller does not send a stop condition after the first data word is clocked in. Instead, after the EEPROM acknowledges receipt of the first data word, the microcontroller can transmit up to fifteen data words. The EEPROM will respond with a zero after each data word received. The microcontroller must terminate the page write sequence with a stop condition (see [Figure 8-3 on page 11](#)).

The data word address lower four bits are internally incremented following the receipt of each data word. The higher data word address bits are not incremented, retaining the memory page row location. When the word address, internally generated, reaches the page boundary, the following byte is placed at the beginning of the same page. If more than sixteen data words are transmitted to the EEPROM, the data word address will “roll over” and previous data will be overwritten.

**ACKNOWLEDGE POLLING:** Once the internally timed write cycle has started and the EEPROM inputs are disabled, acknowledge polling can be initiated. This involves sending a start condition followed by the device address word. The read/write bit is representative of the operation desired. Only if the internal write cycle has completed will the EEPROM respond with a zero allowing the read or write sequence to continue.

## 8. Read Operations

Read operations are initiated the same way as write operations with the exception that the read/write select bit in the device address word is set to one. There are three read operations: current address read, random address read and sequential read.

**CURRENT ADDRESS READ:** The internal data word address counter maintains the last address accessed during the last read or write operation, incremented by one. This address stays valid between operations as long as the chip power is maintained. The address “roll over” during read is from the last byte of the last memory page to the first byte of the first page. The address “roll over” during write is from the last byte of the current page to the first byte of the same page.

Once the device address with the read/write select bit set to one is clocked in and acknowledged by the EEPROM, the current address data word is serially clocked out. The microcontroller does not respond with an input zero but does generate a following stop condition (see [Figure 8-4 on page 11](#)).

**RANDOM READ:** A random read requires a “dummy” byte write sequence to load in the data word address. Once the device address word and data word address are clocked in and acknowledged by the EEPROM, the microcontroller must generate another start condition. The microcontroller now initiates a current address read by sending a device address with the read/write select bit high. The EEPROM acknowledges the device address and serially clocks out the data word. The microcontroller does not respond with a zero but does generate a following stop condition (see [Figure 8-5 on page 11](#)).

**SEQUENTIAL READ:** Sequential reads are initiated by either a current address read or a random address read. After the microcontroller receives a data word, it responds with an acknowledge. As long as the EEPROM receives an acknowledge, it will continue to increment the data word address and serially clock out sequential data words. When the memory address limit is reached, the data word address will “roll over” and the sequential read will continue. The sequential read operation is terminated when the microcontroller does not respond with a zero but does generate a following stop condition (see [Figure 8-6 on page 12](#)).

Figure 8-1. Device Address

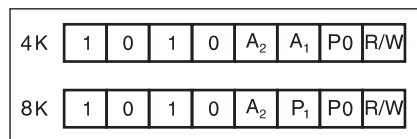

Figure 8-2. Byte Write

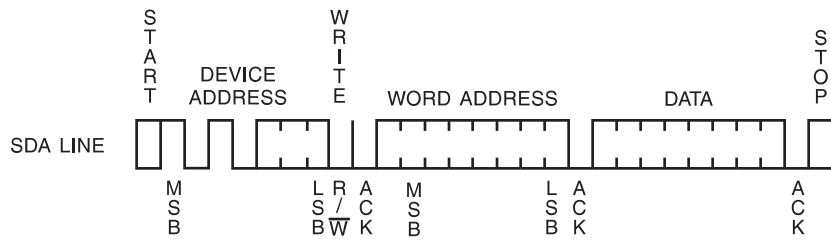

Figure 8-3. Page Write

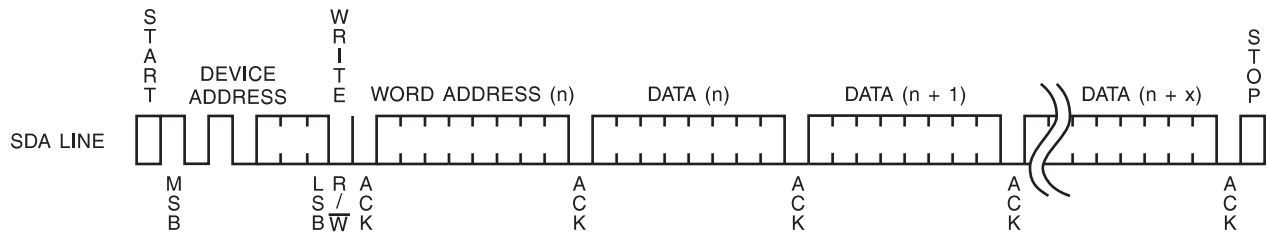

Figure 8-4. Current Address Read

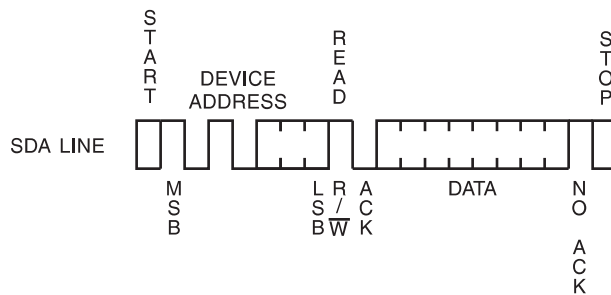
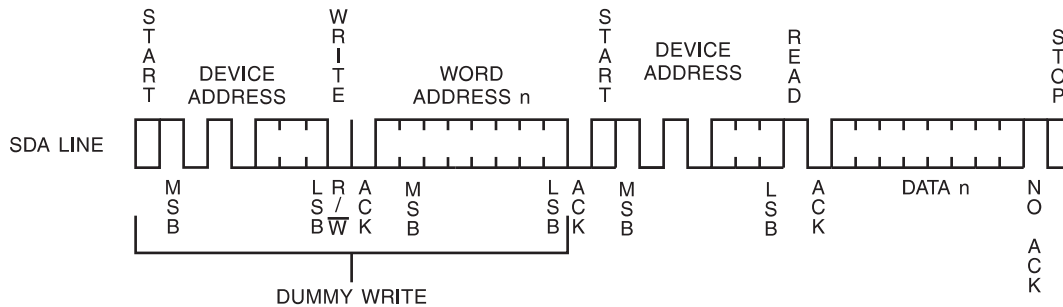
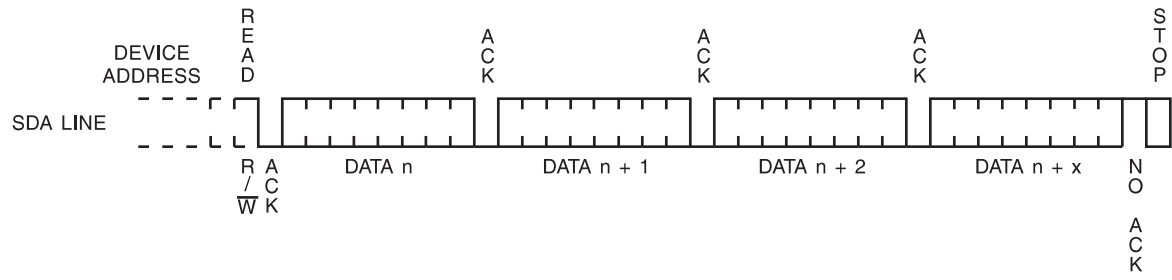

Figure 8-5. Random Read



**Figure 8-6. Sequential Read**



## AT24C04B Ordering Information

Ordering Code	Voltage	Package	Operation Range
AT24C04B-PU (Bulk form only)	1.8	8P3	Lead-free/Halogen-free/ Industrial Temperature (-40°C to 85°C)
AT24C04BN-SH-B <sup>(1)</sup> (NiPdAu Lead Finish)	1.8	8S1	
AT24C04BN-SH-T <sup>(2)</sup> (NiPdAu Lead Finish)	1.8	8S1	
AT24C04B-TH-B <sup>(1)</sup> (NiPdAu Lead Finish)	1.8	8A2	
AT24C04B-TH-T <sup>(2)</sup> (NiPdAu Lead Finish)	1.8	8A2	
AT24C04BY6-YH-T <sup>(2)</sup> (NiPdAu Lead Finish)	1.8	8Y6	
AT24C04B-TSU-T <sup>(2)</sup>	1.8	5TS1	
AT24C04BU3-UU-T <sup>(2)</sup>	1.8	8U3-1	Industrial Temperature (-40°C to 85°C)
AT24C04B-W-11 <sup>(3)</sup>	1.8	Die Sale	

- Notes:
1. “-B” denotes bulk.
  2. “-T” denotes tape and reel. SOIC = 4K per reel. TSSOP, Ultra Thin Mini-MAP, SOT23, and dBGA2 = 5K per reel.
  3. Available in tape and reel and wafer form; order as SL788 for inkless wafer form. Bumped die available upon request. Please contact Serial Interface Marketing.

Package Type	
<b>8P3</b>	8-lead, 0.300" Wide, Plastic Dual Inline Package (PDIP)
<b>8S1</b>	8-lead, 0.150" Wide, Plastic Gull Wing Small Outline (JEDEC SOIC)
<b>8A2</b>	8-lead, 4.4 mm Body, Plastic Thin Shrink Small Outline Package (TSSOP)
<b>8Y6</b>	8-lead, 2.0 mm x 3.00 mm Body, 0.50 mm Pitch, Ultra Thin Mini-MAP, Dual No Lead Package (DFN), (MLP 2x3 mm)
<b>5TS1</b>	5-lead, 2.90 mm x 1.60 mm Body, Plastic Thin Shrink Small Outline Package (SOT23)
<b>8U3-1</b>	8-ball, die Ball Grid Array Package (dBGA2)
Options	
<b>-1.8</b>	Low-voltage (1.8V to 5.5V)



## AT24C08B Ordering Information

Ordering Code	Voltage	Package	Operation Range
AT24C08B-PU (Bulk form only)	1.8	8P3	Lead-free/Halogen-free/ Industrial Temperature (-40°C to 85°C)
AT24C08BN-SH-B <sup>(1)</sup> (NiPdAu Lead Finish)	1.8	8S1	
AT24C08BN-SH-T <sup>(2)</sup> (NiPdAu Lead Finish)	1.8	8S1	
AT24C08B-TH-B <sup>(1)</sup> (NiPdAu Lead Finish)	1.8	8A2	
AT24C08B-TH-T <sup>(2)</sup> (NiPdAu Lead Finish)	1.8	8A2	
AT24C08BY6-YH-T <sup>(2)</sup> (NiPdAu Lead Finish)	1.8	8Y6	
AT24C08B-TSU-T <sup>(2)</sup>	1.8	5TS1	
AT24C08BU3-UU-T <sup>(2)</sup>	1.8	8U3-1	Industrial Temperature (-40°C to 85°C)
AT24C08B-W-11 <sup>(3)</sup>	1.8	Die Sale	

- Notes:
1. “-B” denotes bulk.
  2. “-T” denotes tape and reel. SOIC = 4K per reel. TSSOP, Ultra Thin Mini-MAP, SOT23, and dBGA2 = 5K per reel.
  3. Available in tape and reel and wafer form; order as SL788 for inkless wafer form. Bumped die available upon request. Please contact Serial Interface Marketing.

Package Type	
<b>8P3</b>	8-lead, 0.300" Wide, Plastic Dual Inline Package (PDIP)
<b>8S1</b>	8-lead, 0.150" Wide, Plastic Gull Wing Small Outline (JEDEC SOIC)
<b>8A2</b>	8-lead, 4.4 mm Body, Plastic Thin Shrink Small Outline Package (TSSOP)
<b>8Y6</b>	8-lead, 2.0 mm x 3.00 mm Body, 0.50 mm Pitch, Ultra Thin Mini-MAP, Dual No Lead Package (DFN), (MLP 2x3 mm)
<b>5TS1</b>	5-lead, 2.90 mm x 1.60 mm Body, Plastic Thin Shrink Small Outline Package (SOT23)
<b>8U3-1</b>	8-ball, die Ball Grid Array Package (dBGA2)
Options	
<b>-1.8</b>	Low-voltage (1.8V to 5.5V)

## 9. Part marking scheme

### 9.1 8-PDIP

TOP MARK	Seal Year   Seal Week 	Y = SEAL YEAR	WW = SEAL WEEK
--- --- --- --- --- --- --- ---		6: 2006	0: 2010
A T M L U Y W W		7: 2007	1: 2011
--- --- --- --- --- --- --- ---		8: 2008	2: 2012
0 4 B 1		9: 2009	3: 2013
--- --- --- --- --- --- --- ---			02 = Week 2
* Lot Number			04 = Week 4
			:: : :::: :
Pin 1 Indicator (Dot)			:: : :::: ::
			50 = Week 50
			52 = Week 52

Lot Number to Use ALL Characters in Marking

**BOTTOM MARK**  
No Bottom Mark

### 9.2 8-SOIC

TOP MARK	Seal Year   Seal Week 	Y = SEAL YEAR	WW = SEAL WEEK
--- --- --- --- --- --- --- ---		6: 2006	0: 2010
A T M L H Y W W		7: 2007	1: 2011
--- --- --- --- --- --- --- ---		8: 2008	2: 2012
0 4 B 1		9: 2009	3: 2013
--- --- --- --- --- --- --- ---			02 = Week 2
* Lot Number			04 = Week 4
			:: : :::: :
Pin 1 Indicator (Dot)			:: : :::: ::
			50 = Week 50
			52 = Week 52

Lot Number to Use ALL Characters in Marking

**BOTTOM MARK**  
No Bottom Mark

### 9.3 8-TSSOP

#### TOP MARK

```

Pin 1 Indicator (Dot)
|
|---|---|---|---|
*  H  Y  W  W
|---|---|---|---|
0  4  B      1
|---|---|---|---|

```

Y = SEAL YEAR

6: 2006	0: 2010
7: 2007	1: 2011
8: 2008	2: 2012
9: 2009	3: 2013

WW = SEAL WEEK

02 = Week 2
04 = Week 4
:: : :::: :
:: : :::: ::
50 = Week 50
52 = Week 52

#### BOTTOM MARK

```

|---|---|---|---|---|---|
P  H
|---|---|---|---|---|---|
A  A  A  A  A  A  A
|---|---|---|---|---|---|
<- Pin 1 Indicator

```

### 9.4 8-Ultra Thin Mini MAP

#### TOP MARK

```

|---|---|---|
0  4  B
|---|---|---|
H  1
|---|---|---|
Y  X  X
|---|---|---|
*
|
Pin 1 Indicator (Dot)

```

Y = YEAR OF ASSEMBLY

XX = ATMEL LOT NUMBER TO COORESPOND WITH  
NSEB TRACE CODE LOG BOOK.  
(e.g. XX = AA, AB, AC, ...AX, AY, AZ)

Y = SEAL YEAR

6: 2006	0: 2010
7: 2007	1: 2011
8: 2008	2: 2012
9: 2009	3: 2013







```
LINE 1----->    04BU
LINE 2----->    YMTC
                  |<-- Pin 1 This Corner

XXX = Device
U = Material Set
Y = One Digit Year Code
M = Seal Month (Use Alpha Designator A-L)
TC = Trace Code
```

10. Packaging Information

8P3 – PDIP

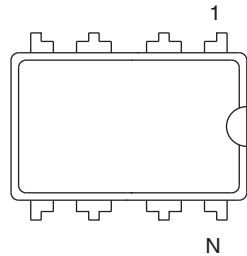

Top View

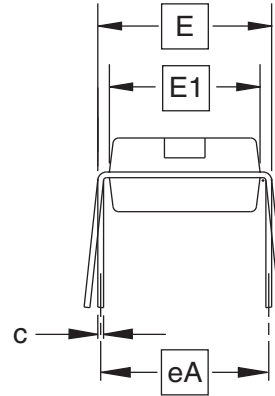

End View

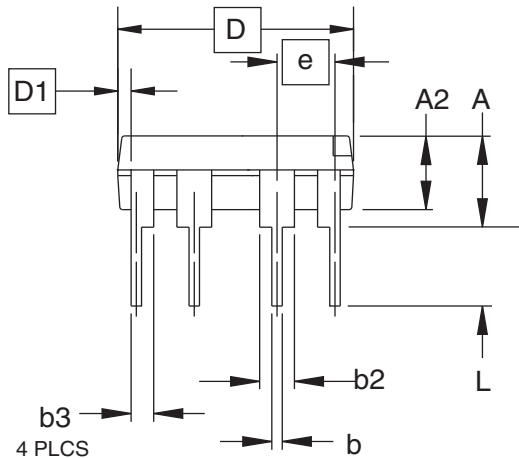

Side View

COMMON DIMENSIONS  
(Unit of Measure = inches)

SYMBOL	MIN	NOM	MAX	NOTE
A	–	–	0.210	2
A2	0.115	0.130	0.195	
b	0.014	0.018	0.022	5
b2	0.045	0.060	0.070	6
b3	0.030	0.039	0.045	6
c	0.008	0.010	0.014	
D	0.355	0.365	0.400	3
D1	0.005	–	–	3
E	0.300	0.310	0.325	4
E1	0.240	0.250	0.280	3
e	0.100 BSC			
eA	0.300 BSC			4
L	0.115	0.130	0.150	2

- Notes:
1. This drawing is for general information only; refer to JEDEC Drawing MS-001, Variation BA, for additional information.
  2. Dimensions A and L are measured with the package seated in JEDEC seating plane Gauge GS-3.
  3. D, D1 and E1 dimensions do not include mold Flash or protrusions. Mold Flash or protrusions shall not exceed 0.010 inch.
  4. E and eA measured with the leads constrained to be perpendicular to datum.
  5. Pointed or rounded lead tips are preferred to ease insertion.
  6. b2 and b3 maximum dimensions do not include Dambar protrusions. Dambar protrusions shall not exceed 0.010 (0.25 mm).

01/09/02



2325 Orchard Parkway  
San Jose, CA 95131

**TITLE**  
8P3, 8-lead, 0.300" Wide Body, Plastic Dual  
In-line Package (PDIP)

**DRAWING NO.**  
8P3

**REV.**  
B



# 8S1 – JEDEC SOIC

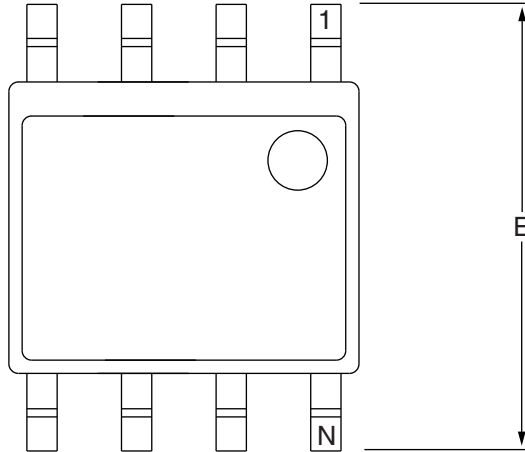

Top View

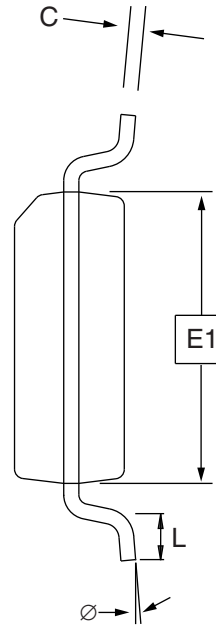

End View

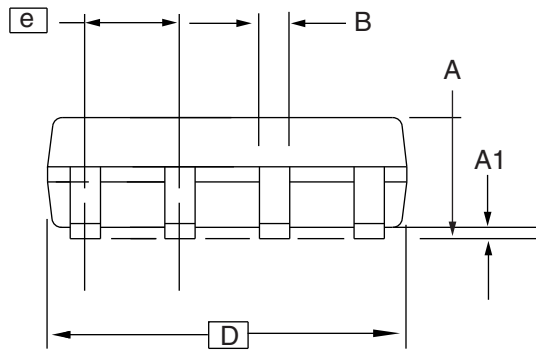

Side View

**COMMON DIMENSIONS**  
(Unit of Measure = mm)

SYMBOL	MIN	NOM	MAX	NOTE
A	1.35	–	1.75	
A1	0.10	–	0.25	
b	0.31	–	0.51	
C	0.17	–	0.25	
D	4.80	–	5.00	
E1	3.81	–	3.99	
E	5.79	–	6.20	
e	1.27 BSC			
L	0.40	–	1.27	
Ø	0°	–	8°	

Note: These drawings are for general information only. Refer to JEDEC Drawing MS-012, Variation AA for proper dimensions, tolerances, datums, etc.

10/7/03



1150 E. Cheyenne Mtn. Blvd.  
Colorado Springs, CO 80906

**TITLE**  
8S1, 8-lead (0.150" Wide Body), Plastic Gull Wing  
Small Outline (JEDEC SOIC)

**DRAWING NO.**  
8S1

**REV.**  
B

8A2 – TSSOP

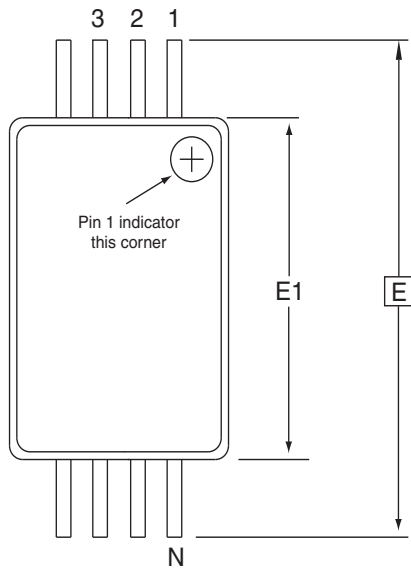

Top View

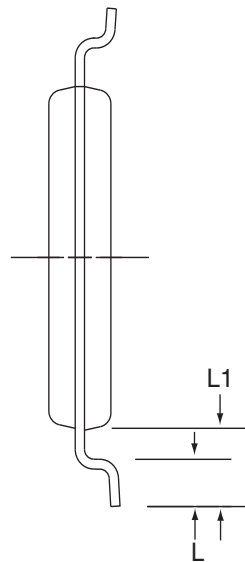

End View

COMMON DIMENSIONS  
(Unit of Measure = mm)

SYMBOL	MIN	NOM	MAX	NOTE
D	2.90	3.00	3.10	2, 5
E	6.40 BSC			
E1	4.30	4.40	4.50	3, 5
A	-	-	1.20	
A2	0.80	1.00	1.05	
b	0.19	-	0.30	4
e	0.65 BSC			
L	0.45	0.60	0.75	
L1	1.00 REF			

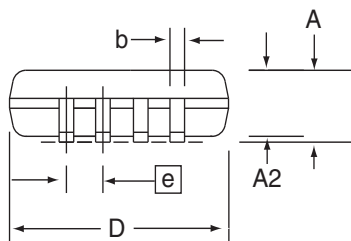

Side View

- Notes:
1. This drawing is for general information only. Refer to JEDEC Drawing MO-153, Variation AA, for proper dimensions, tolerances, datums, etc.
  2. Dimension D does not include mold Flash, protrusions or gate burrs. Mold Flash, protrusions and gate burrs shall not exceed 0.15 mm (0.006 in) per side.
  3. Dimension E1 does not include inter-lead Flash or protrusions. Inter-lead Flash and protrusions shall not exceed 0.25 mm (0.010 in) per side.
  4. Dimension b does not include Dambar protrusion. Allowable Dambar protrusion shall be 0.08 mm total in excess of the b dimension at maximum material condition. Dambar cannot be located on the lower radius of the foot. Minimum space between protrusion and adjacent lead is 0.07 mm.
  5. Dimension D and E1 to be determined at Datum Plane H.

5/30/02



2325 Orchard Parkway  
San Jose, CA 95131

**TITLE**  
8A2, 8-lead, 4.4 mm Body, Plastic  
Thin Shrink Small Outline Package (TSSOP)

**DRAWING NO.**  
8A2

**REV.**  
B



# 8Y6 - Mini Map

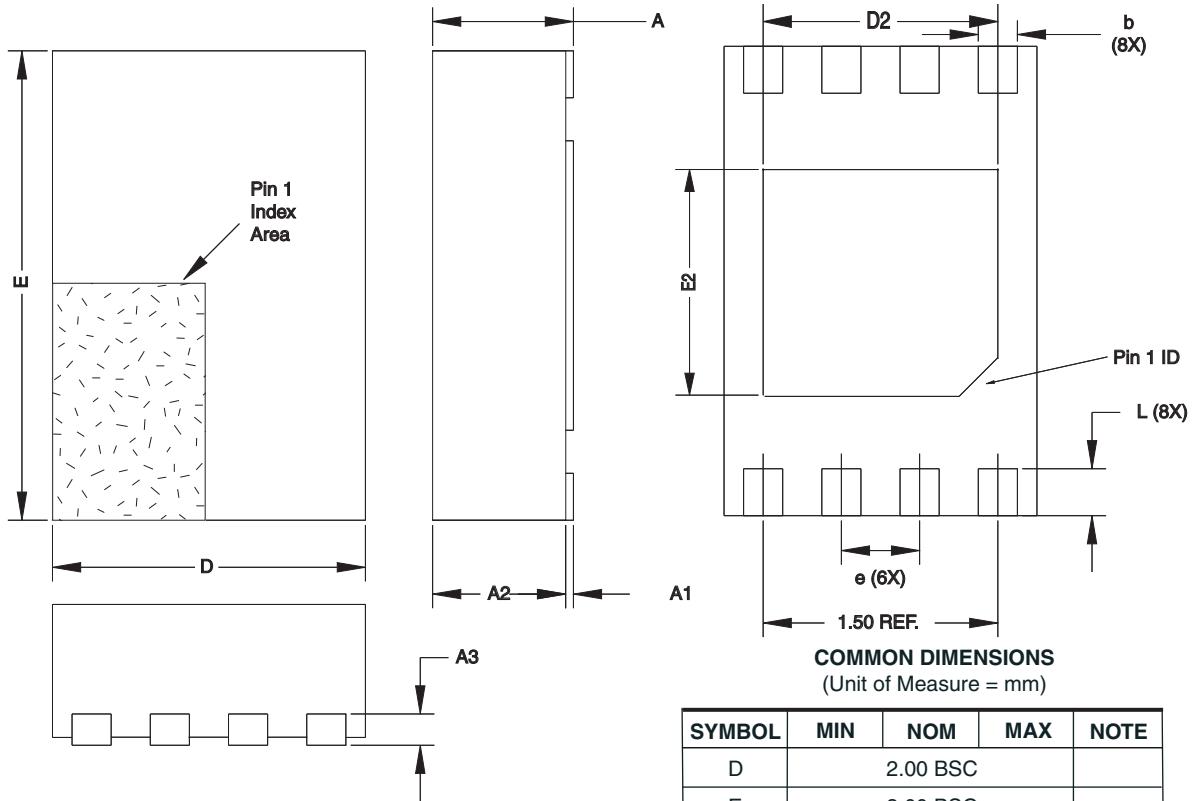

**COMMON DIMENSIONS**  
(Unit of Measure = mm)

SYMBOL	MIN	NOM	MAX	NOTE
D		2.00 BSC		
E		3.00 BSC		
D2	1.40	1.50	1.60	
E2	-	-	1.40	
A	-	-	0.60	
A1	0.0	0.02	0.05	
A2	-	-	0.55	
A3		0.20 REF		
L	0.20	0.30	0.40	
e		0.50 BSC		
b	0.20	0.25	0.30	2

- Notes:
1. This drawing is for general information only. Refer to JEDEC Drawing MO-229, for proper dimensions, tolerances, datums, etc.
  2. Dimension b applies to metallized terminal and is measured between 0.15 mm and 0.30 mm from the terminal tip. If the terminal has the optional radius on the other end of the terminal, the dimension should not be measured in that radius area.
  3. Soldering the large thermal pad is optional, but not recommended. No electrical connection is accomplished to the device through this pad, so if soldered it should be tied to ground

10/16/07



2325 Orchard Parkway  
San Jose, CA 95131

**TITLE**

**8Y6**, 8-lead 2.0 x 3.0 mm Body, 0.50 mm Pitch, Ultra Thin Mini-Map, Dual No Lead Package (DFN) ,(MLP 2x3)

**DRAWING NO.**

8Y6

**REV.**

D

5TS1 – SOT23

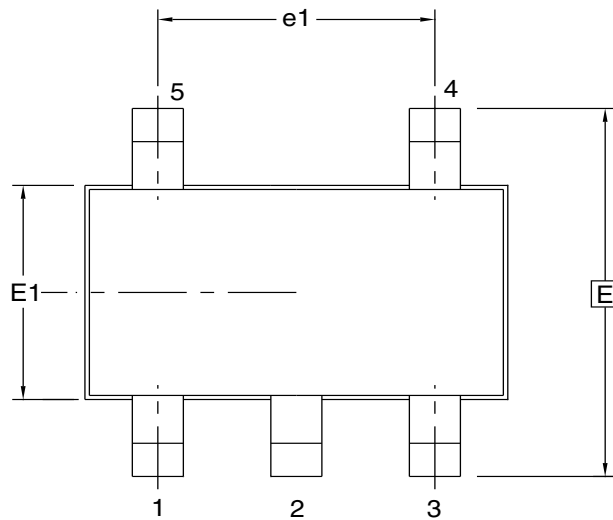

Top View

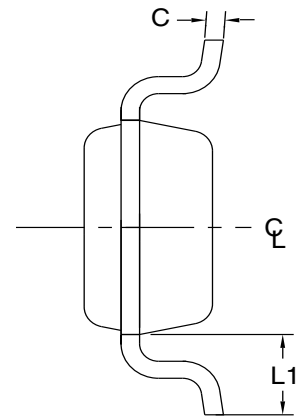

End View

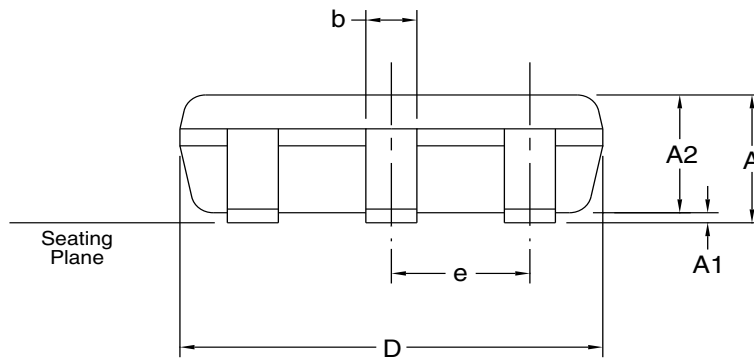

Side View

COMMON DIMENSIONS  
(Unit of Measure = mm)

SYMBOL	MIN	NOM	MAX	NOTE
A	–	–	1.10	
A1	0.00	–	0.10	
A2	0.70	0.90	1.00	
c	0.08	–	0.20	4
D	2.90 BSC			2, 3
E	2.80 BSC			2, 3
E1	1.60 BSC			2, 3
L1	0.60 REF			
e	0.95 BSC			
e1	1.90 BSC			
b	0.30	–	0.50	4, 5

- NOTES:
1. This drawing is for general information only. Refer to JEDEC Drawing MO-193, Variation AB, for additional information.
  2. Dimension D does not include mold flash, protrusions, or gate burrs. Mold flash, protrusions, or gate burrs shall not exceed 0.15 mm per end. Dimension E1 does not include interlead flash or protrusion. Interlead flash or protrusion shall not exceed 0.15 mm per side.
  3. The package top may be smaller than the package bottom. Dimensions D and E1 are determined at the outermost extremes of the plastic body exclusive of mold flash, tie bar burrs, gate burrs, and interlead flash, but including any mismatch between the top and bottom of the plastic body.
  4. These dimensions apply to the flat section of the lead between 0.08 mm and 0.15 mm from the lead tip.
  5. Dimension "b" does not include Dambar protrusion. Allowable Dambar protrusion shall be 0.08 mm total in excess of the "b" dimension at maximum material condition. The Dambar cannot be located on the lower radius of the foot. Minimum space between protrusion and an adjacent lead shall not be less than 0.07 mm.

6/25/03



1150 E. Cheyenne Mtn. Blvd.  
Colorado Springs, CO 80906

TITLE

5TS1, 5-lead, 1.60 mm Body, Plastic Thin Shrink  
Small Outline Package (SHRINK SOT)

DRAWING NO.

PO5TS1

REV.

A



# 8U3-1 – dBGA2

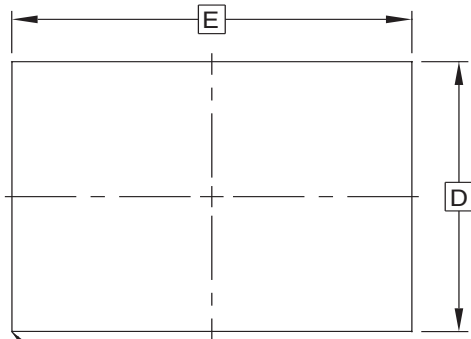

Top View

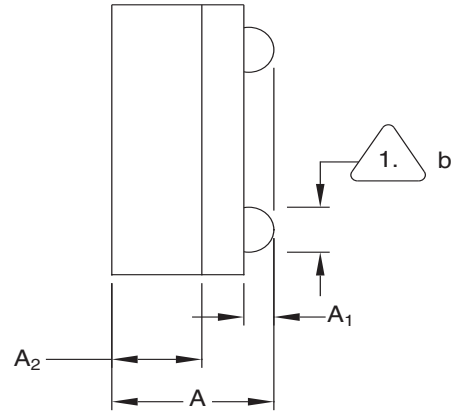

Side View

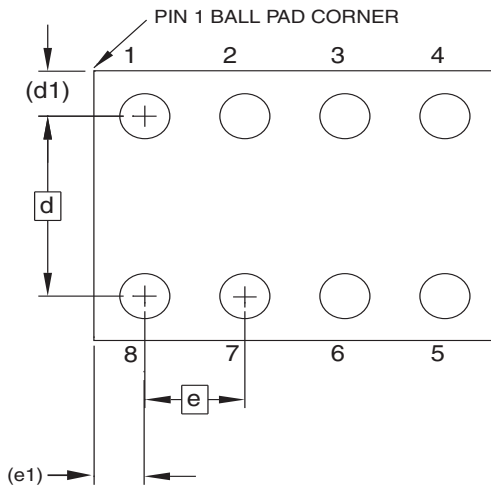

Bottom View  
8 SOLDER BALLS

COMMON DIMENSIONS  
(Unit of Measure = mm)

SYMBOL	MIN	NOM	MAX	NOTE
A	0.71	0.81	0.91	
A1	0.10	0.15	0.20	
A2	0.40	0.45	0.50	
b	0.20	0.25	0.30	
D	1.50 BSC			
E	2.00 BSC			
e	0.50 BSC			
e1	0.25 REF			
d	1.00 BSC			
d1	0.25 REF			

1. Dimension "b" is measured at the maximum solder ball diameter.

This drawing is for general information only.

6/24/03



1150 E. Cheyenne Mtn. Blvd.  
Colorado Springs, CO 80906

**TITLE**  
8U3-1, 8-ball, 1.50 x 2.00 mm Body, 0.50 mm pitch,  
Small Die Ball Grid Array Package (dBGA2)

**DRAWING NO.**  
PO8U3-1

**REV.**  
A



## 11. Revision History

Doc. Rev.	Date	Comments
5226D	7/2008	Removed 'Preliminary' status
5226C	2/2008	Text changes on page 4 and 9
5226B	8/2007	Updated to new template Updated common Figures Added Package Marking tables
5226A	6/2007	Initial document release



## Headquarters

---

**Atmel Corporation**  
2325 Orchard Parkway  
San Jose, CA 95131  
USA  
Tel: 1(408) 441-0311  
Fax: 1(408) 487-2600

## International

---

**Atmel Asia**  
Room 1219  
Chinachem Golden Plaza  
77 Mody Road Tsimshatsui  
East Kowloon  
Hong Kong  
Tel: (852) 2721-9778  
Fax: (852) 2722-1369

**Atmel Europe**  
Le Krebs  
8, Rue Jean-Pierre Timbaud  
BP 309  
78054 Saint-Quentin-en-  
Yvelines Cedex  
France  
Tel: (33) 1-30-60-70-00  
Fax: (33) 1-30-60-71-11

**Atmel Japan**  
9F, Tonetsu Shinkawa Bldg.  
1-24-8 Shinkawa  
Chuo-ku, Tokyo 104-0033  
Japan  
Tel: (81) 3-3523-3551  
Fax: (81) 3-3523-7581

## Product Contact

---

**Web Site**  
[www.atmel.com](http://www.atmel.com)

**Technical Support**  
[s\\_eeeprom@atmel.com](mailto:s_eeeprom@atmel.com)

**Sales Contact**  
[www.atmel.com/contacts](http://www.atmel.com/contacts)

**Literature Requests**  
[www.atmel.com/literature](http://www.atmel.com/literature)

---

**Disclaimer:** The information in this document is provided in connection with Atmel products. No license, express or implied, by estoppel or otherwise, to any intellectual property right is granted by this document or in connection with the sale of Atmel products. **EXCEPT AS SET FORTH IN ATMEL'S TERMS AND CONDITIONS OF SALE LOCATED ON ATMEL'S WEB SITE, ATMEL ASSUMES NO LIABILITY WHATSOEVER AND DISCLAIMS ANY EXPRESS, IMPLIED OR STATUTORY WARRANTY RELATING TO ITS PRODUCTS INCLUDING, BUT NOT LIMITED TO, THE IMPLIED WARRANTY OF MERCHANTABILITY, FITNESS FOR A PARTICULAR PURPOSE, OR NON-INFRINGEMENT. IN NO EVENT SHALL ATMEL BE LIABLE FOR ANY DIRECT, INDIRECT, CONSEQUENTIAL, PUNITIVE, SPECIAL OR INCIDENTAL DAMAGES (INCLUDING, WITHOUT LIMITATION, DAMAGES FOR LOSS OF PROFITS, BUSINESS INTERRUPTION, OR LOSS OF INFORMATION) ARISING OUT OF THE USE OR INABILITY TO USE THIS DOCUMENT, EVEN IF ATMEL HAS BEEN ADVISED OF THE POSSIBILITY OF SUCH DAMAGES.** Atmel makes no representations or warranties with respect to the accuracy or completeness of the contents of this document and reserves the right to make changes to specifications and product descriptions at any time without notice. Atmel does not make any commitment to update the information contained herein. Unless specifically provided otherwise, Atmel products are not suitable for, and shall not be used in, automotive applications. Atmel's products are not intended, authorized, or warranted for use as components in applications intended to support or sustain life.

© 2008 Atmel Corporation. All rights reserved. Atmel®, logo and combinations thereof, and others, are registered trademarks or trademarks of Atmel Corporation or its subsidiaries. Other terms and product names may be trademarks of others.