



*Rely on ECE's Relays,
and You Always Relax!*

POWER TYPE SOLID STATE RELAY ESR5 SERIES

UL [®] **US** E155181(R)

■ FEATURES

- Optically isolated.
- Input LED indicator.
- High dv/dt and high blocking voltage.
- Low input power consumption.
- TTL and CMOS Compatible.
- Zero voltage turn-on, zero current turn-off (minizes EMI/RFI).
- High surge rating allows lamp and motor load switching.
- Output snubber circuit protection.



■ PART NUMBERING SYSTEM

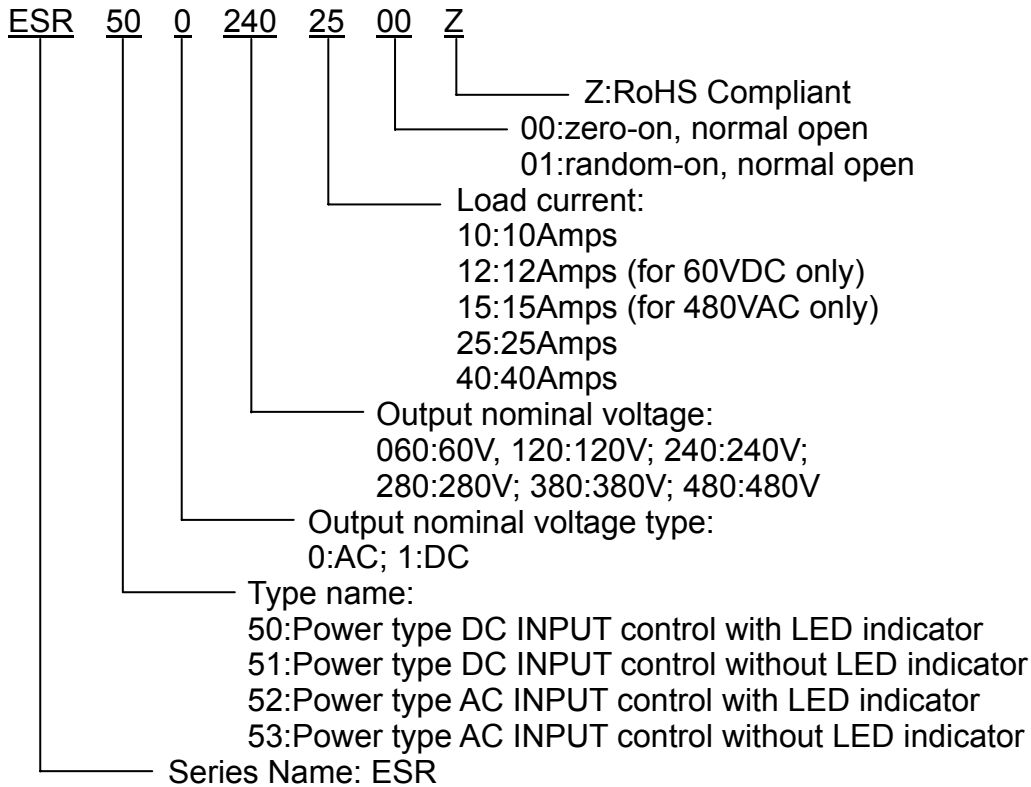

■ OPTIONS:

Protective cover available
P/N: 436-41100





TEMPERAURE DERATING CHART

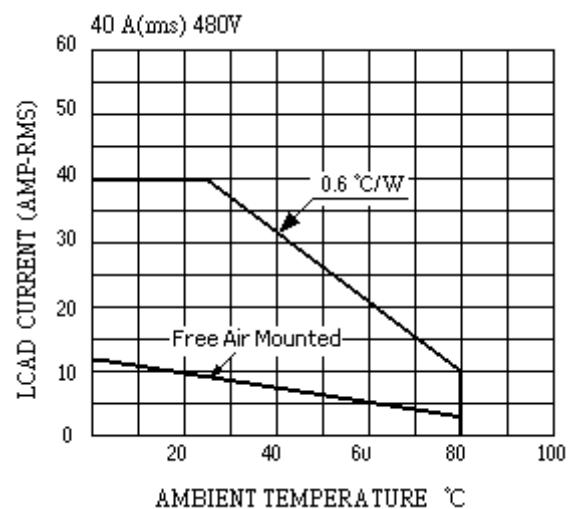
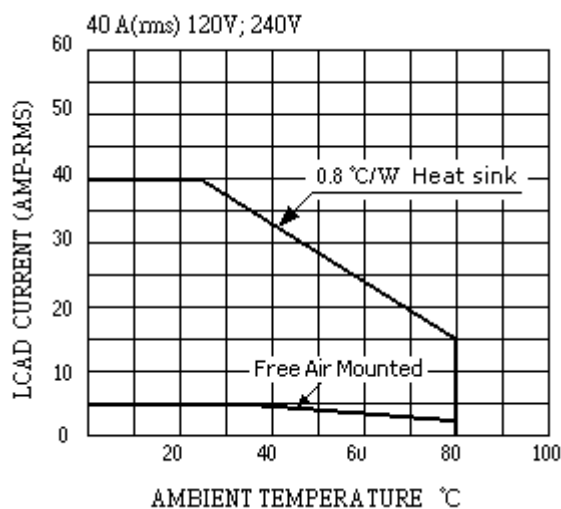
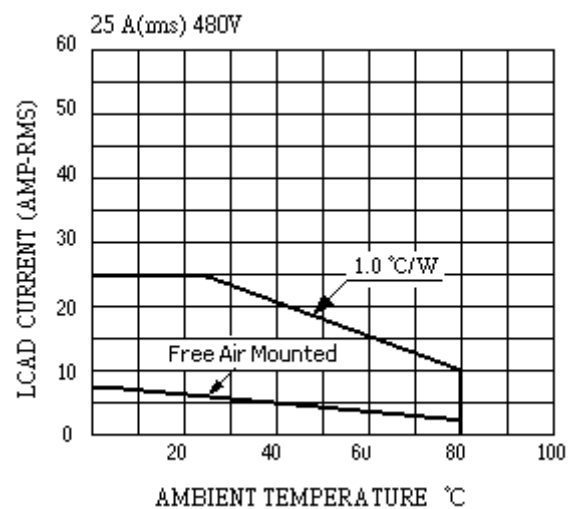
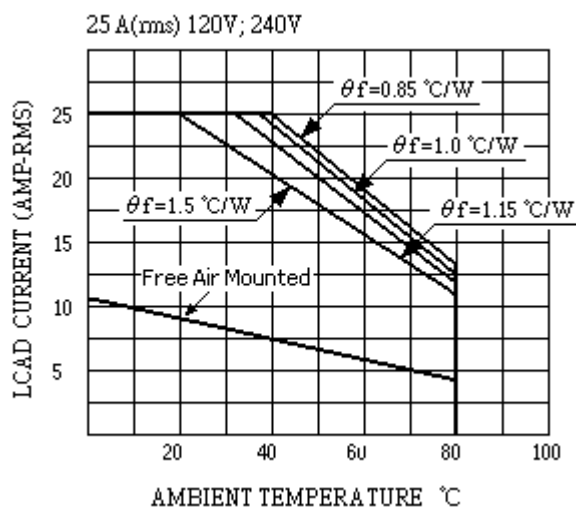
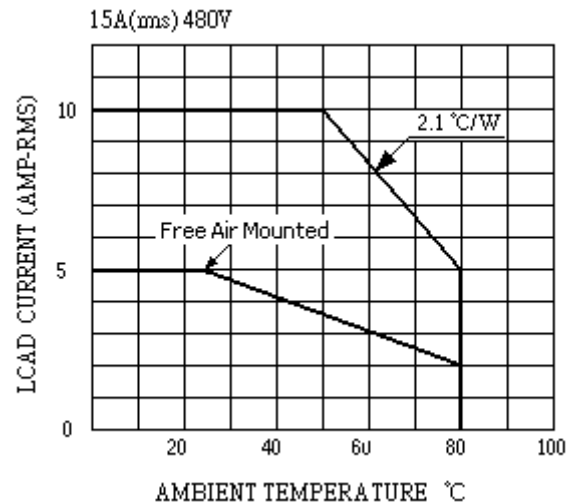
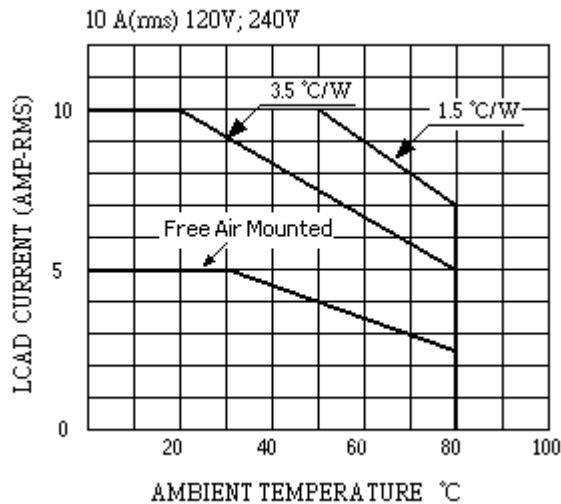

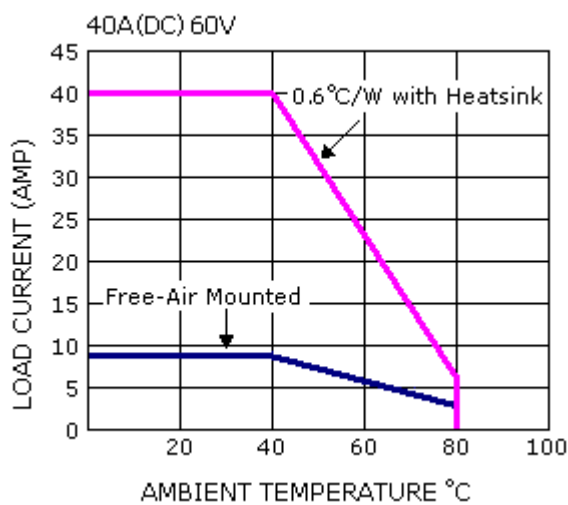
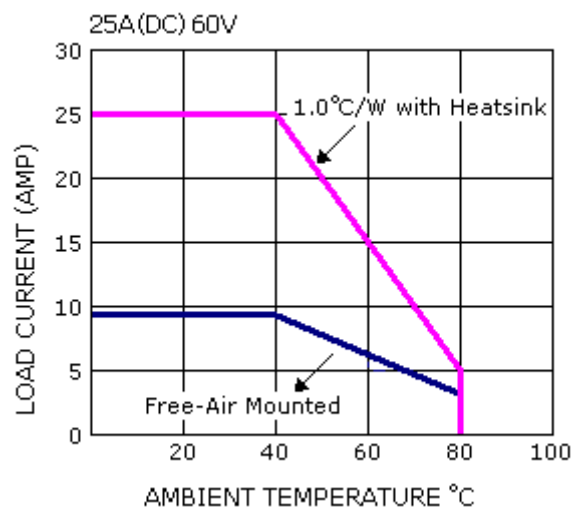
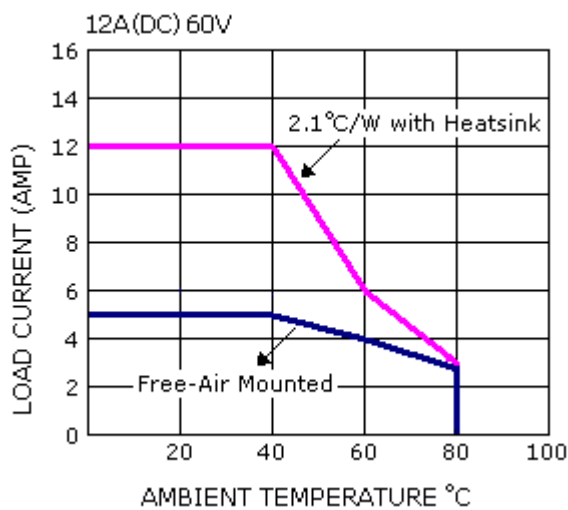
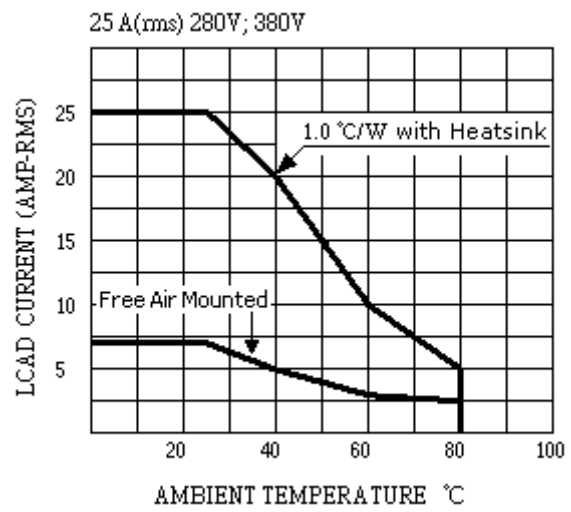
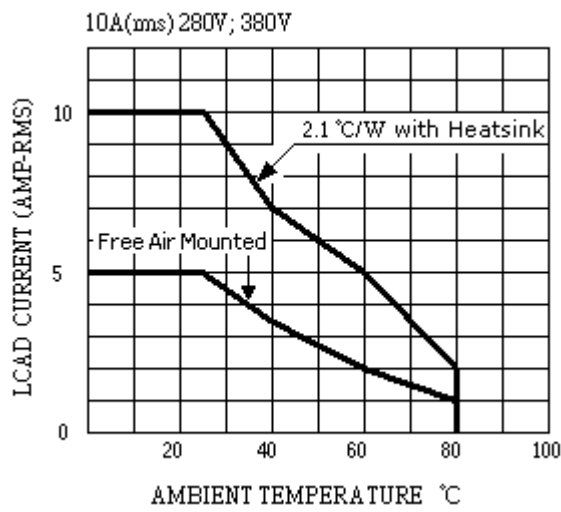

■ DIMENSIONS UNIT:mm(inch)

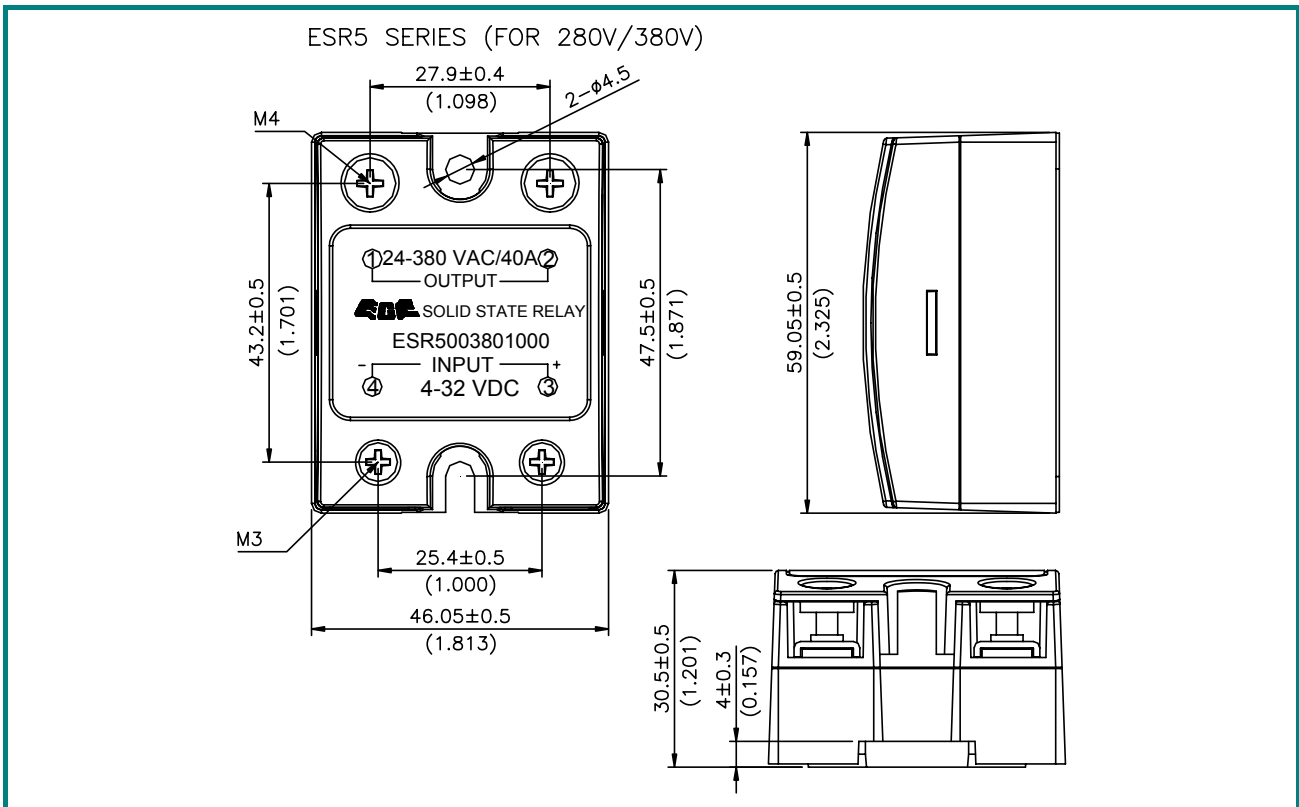
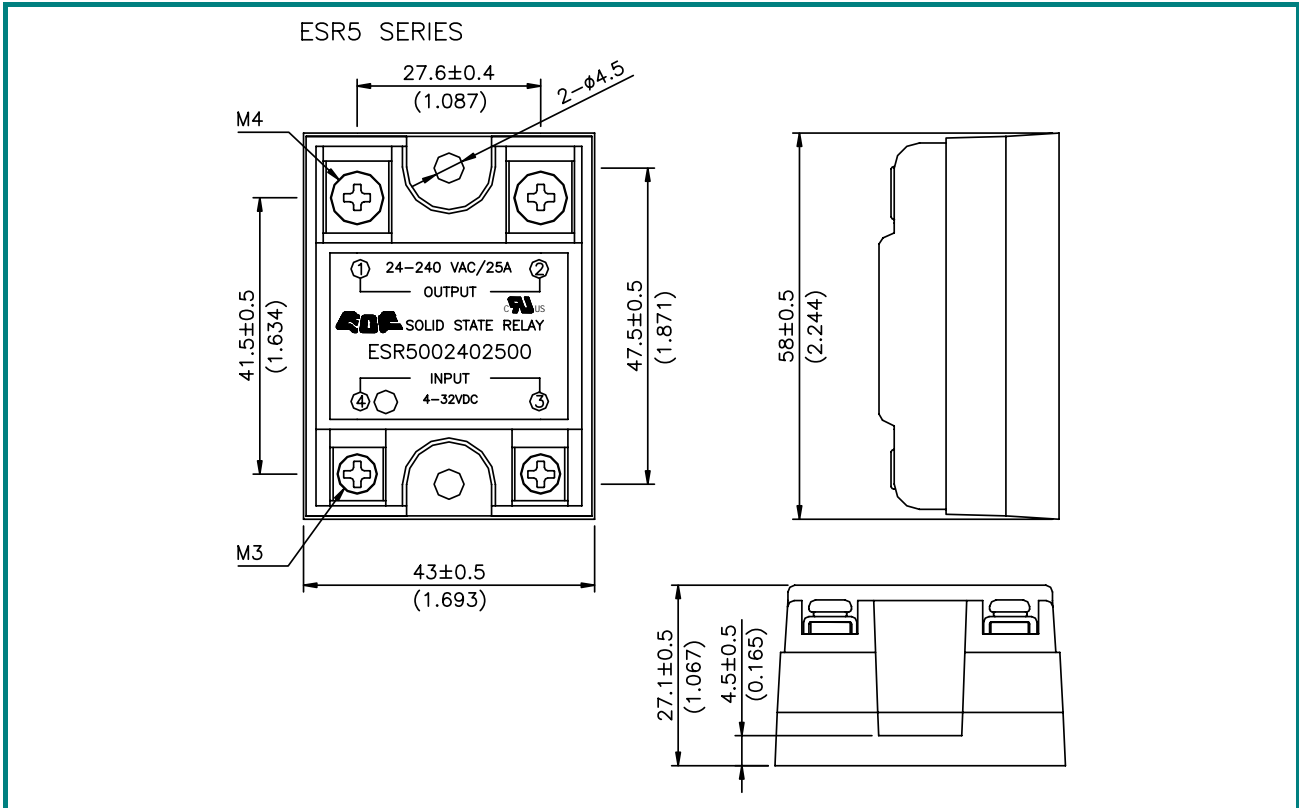



■ SPECIFICATIONS (DC INPUT CONTROL)

◆ MAX. LOAD CURRENT: 12A/25A/40A, 60VDC

Type	ESR501	ESR511	ESR501	ESR511	ESR501	ESR511
Description	0601201		0602501		0604001	
■ Input Circuit						
LED Indicate	YES	NO	YES	NO	YES	NO
Control Voltage Range	4-32 VDC	3-32 VDC	4-32 VDC	3-32 VDC	4-32 VDC	3-32 VDC
Control Current	16mA Max.		16mA Max.		16mA Max.	
Release Voltage	1 VDC		1 VDC		1 VDC	
■ Output Circuit						
Load Voltage	60 VDC		60 VDC		60 VDC	
Operating Range	0-60 VDC		0-60 VDC		0-60 VDC	
Nominal Current	12 ADC		25 ADC		40 ADC	
Non Repetitive Overload Current (300us)	260A		344A		344A	
On state Voltage Drop	0.19V Max.		0.38V Max.		0.834V Max.	
On-state Resistance	16mΩ Max.		16mΩ Max.		20mΩ Max.	
Off state Leakage Current	<1mA		<1mA		<1mA	
Min. Load Current	100mA		100mA		100mA	
Turn On Time (at Nominal Voltage)	1ms		1ms		1ms	
Turn Off Time (at Nominal Voltage)	1ms		1ms		1ms	
■ General Characteristics						
Insulation Resistance	DC 500V 1000MΩ (Between Input & Output)					
Dielectric Strength	2000Vrms, 1 minute, output-case 3000Vrms, 1 minute (Between Input & Output)					
Capacitance	15pF Max. (Between Input & Output)					
Operating Temperature	-20°C ~ +80°C					
Storage Temperature	-40°C ~ +100°C					
Heat Sink	2.1°C/W (Max. Load current)		1.0°C/W (Max. Load current)		0.6°C/W (Max. Load current)	
Weight	95g					



■ SPECIFICATIONS (DC INPUT CONTROL)

◆ MAX. LOAD CURRENT: 10A(rms), 120V/240V

Description \ Type	ESR500				ESR510			
	1201000	2401000	1201001	2401001	1201000	2401000	1201001	2401001
■ Input Circuit								
LED Indicate	YES				NO			
Control Voltage Range	4-32 VDC				3-32 VDC			
Control Current	15mA Max.				16mA Max.			
Min. Turn-off Voltage	1.5 VDC				1 VDC			
Input Impedance	2.0K Ω Min.				2.0K Ω Min.			
■ Output Circuit								
Max. Load Current	10A (rms)				10A (rms)			
Nominal load Voltage (VAC)	120	240	120	240	120	240	120	240
Load Voltage Range (VAC)	24-140	24-280	24-140	24-280	24-140	24-280	24-140	24-280
Non-Repetitive Max. Peak Voltage (VAC)	400	600	400	600	400	600	400	600
Non-Repetitive Max. Peak Current	125A				125A			
Max. Off-state Leakage Current	10mA				10mA			
Max. On-state Voltage Drop	1.6V				1.6V			
Min. Load Current	50mA				50mA			
Max. Off-state Slew Rated (dv/dt)	250V/ μ s				250V/ μ s			
Operating Frequency Range	47Hz ~ 63Hz				47Hz ~ 63Hz			
■ General Characteristics								
Zero-on or Random-on	Z		R		Z		R	
Max. Turn-on Time (60Hz)	8.3ms		100 μ s		8.3ms		100 μ s	
Max. Turn-off Time (60Hz)	8.3ms		8.3ms		8.3ms		8.3ms	
Insulation Resistance	DC 500V 10 ⁹ Ω Min. (Between Input & Output, Input / Output & Case)							
Dielectric Strength	3.5K VAC (Between Input & Output)							
Capacitance	15pF Max. (Between Input & Output)							
Operating Temperature	-20 $^{\circ}$ C ~ +80 $^{\circ}$ C							
Storage Temperature	-40 $^{\circ}$ C ~ +100 $^{\circ}$ C							
Heat Sink	3.5 $^{\circ}$ C/W (Max. Load Current)							



■ SPECIFICATIONS (DC INPUT CONTROL)

◆ MAX. LOAD CURRENT: 25A(rms), 120V/240V

Description \ Type	ESR500				ESR510			
	1202500	2402500	1202501	2402501	1202500	2402500	1202501	2402501
■ Input Circuit								
LED Indicate	YES				NO			
Control Voltage Range	4-32 VDC				3-32 VDC			
Control Current	15mA Max.				16mA Max.			
Min. Turn-off Voltage	1.5 VDC				1 VDC			
Input Impedance	2.0KΩ Min.				2.0KΩ Min.			
■ Output Circuit								
Max. Load Current	25A (rms)				25A (rms)			
Nominal load Voltage (VAC)	120	240	120	240	120	240	120	240
Load Voltage Range (VAC)	24-140	24-280	24-140	24-280	24-140	24-280	24-140	24-280
Non-Repetitive Max. Peak Voltage (VAC)	400	600	400	600	400	600	400	600
Non-Repetitive Max. Peak Current	260A				260A			
Max. Off-state Leakage Current	10mA				10mA			
Max. On-state Voltage Drop	1.6V				1.6V			
Min. Load Current	100mA				100mA			
Max. Off-state Slew Rated (dv/dt)	250V/μs				250V/μs			
Operating Frequency Range	47Hz ~ 63Hz				47Hz ~ 63Hz			
■ General Characteristics								
Zero-on or Random-on	Z		R		Z		R	
Max. Turn-on Time (60Hz)	8.3ms		100μs		8.3ms		100μs	
Max. Turn-off Time (60Hz)	8.3ms		8.3ms		8.3ms		8.3ms	
Insulation Resistance	DC 500V 10 ⁹ Ω Min. (Between Input & Output, Input / Output & Case)							
Dielectric Strength	3.5K VAC (Between Input & Output)							
Capacitance	15pF Max. (Between Input & Output)							
Operating Temperature	-20°C ~ +80°C							
Storage Temperature	-40°C ~ +100°C							
Heat Sink	1.5°C/W (Max. Load Current)							



■ SPECIFICATIONS (DC INPUT CONTROL)

◆ MAX. LOAD CURRENT: 40A(rms), 120V/240V

Description \ Type	ESR500				ESR510			
	1204000	2404000	1204001	2404001	1204000	2404000	1204001	2404001
■ Input Circuit								
LED Indicate	YES				NO			
Control Voltage Range	4-32 VDC				3-32 VDC			
Control Current	15mA Max.				16mA Max.			
Min. Turn-off Voltage	1.5 VDC				1 VDC			
Input Impedance	2.0KΩ Min.				2.0KΩ Min.			
■ Output Circuit								
Max. Load Current	40A (rms)				40A (rms)			
Nominal load Voltage (VAC)	120	240	120	240	120	240	120	240
Load Voltage Range (VAC)	24-140	24-280	24-140	24-280	24-140	24-280	24-140	24-280
Non-Repetitive Max. Peak Voltage (VAC)	400	600	400	600	400	600	400	600
Non-Repetitive Max. Peak Current	315A				315A			
Max. Off-state Leakage Current	10mA				10mA			
Max. On-state Voltage Drop	1.8V				1.8V			
Min. Load Current	100mA				100mA			
Max. Off-state Slew Rated (dv/dt)	250V/μs				250V/μs			
Operating Frequency Range	47Hz ~ 63Hz				47Hz ~ 63Hz			
■ General Characteristics								
Zero-on or Random-on	Z		R		Z		R	
Max. Turn-on Time (60Hz)	8.3ms		100μs		8.3ms		100μs	
Max. Turn-off Time (60Hz)	8.3ms		8.3ms		8.3ms		8.3ms	
Insulation Resistance	DC 500V 10 ⁹ Ω Min. (Between Input & Output, Input / Output & Case)							
Dielectric Strength	3.5K VAC (Between Input & Output)							
Capacitance	15pF Max. (Between Input & Output)							
Operating Temperature	-20°C ~ +75°C							
Storage Temperature	-40°C ~ +100°C							
Heat Sink	0.8°C/W (Max. Load Current)							



■ SPECIFICATIONS (DC INPUT CONTROL)

◆ MAX. LOAD CURRENT: 10A(rms)/25A(rms), 280V/380V

Description \ Type	ESR500				ESR510			
	2801000	3801000	2802500	3802500	2801000	3801000	2802500	3802500
■ Input Circuit								
LED Indicate	YES				NO			
Control Voltage Range	4-32 VDC				3-32 VDC			
Control Current	16mA Max.				16mA Max.			
Min. Turn-off Voltage	1.5 VDC				1 VDC			
Input Impedance	---				---			
■ Output Circuit								
Max. Load Current	10A (rms)		25A (rms)		10A (rms)		25A (rms)	
Nominal load Voltage (VAC)	280	380	280	380	280	380	280	380
Load Voltage Range (VAC)	24-280	24-380	24-280	24-380	24-280	24-380	24-280	24-380
Non-Repetitive Max. Peak Voltage	600	800	600	800	600	800	600	800
Non-Repetitive Max. Peak Current	160A	200A	250A	250A	160A	200A	250A	250A
Max. Off-state Leakage Current	3mA				3mA			
Max. On-state Voltage Drop	1.8V				1.8V			
Min. Load Current	100mA				100mA			
Max. Off-state Slew Rated (dv/dt)	400V/μs	400V/μs	400V/μs	500V/μs	400V/μs	400V/μs	400V/μs	500V/μs
Operating Frequency Range	47Hz ~ 63Hz				47Hz ~ 63Hz			
■ General Characteristics								
Zero-on or Random-on	Z							
Max. Turn-on Time (60Hz)	8.3ms							
Max. Turn-off Time (60Hz)	8.3ms							
Insulation Resistance	DC 500V 10 ⁹ Ω Min. (Between Input & Output, Input / Output & Case)							
Dielectric Strength	3.5K VAC (Between Input & Output)							
Capacitance	15pF Max. (Between Input & Output)							
Operating Temperature	-20°C ~ +80°C							
Storage Temperature	-40°C ~ +100°C							
Heat Sink	2.1°C/W (10A)		1.0°C/W (25A)		2.1°C/W (10A)		1.0°C/W (25A)	



■ SPECIFICATIONS (DC INPUT CONTROL)

◆ MAX. LOAD CURRENT: 15A(rms)/25A(rms), 480V

Type \ Description	ESR500	ESR510	ESR500	ESR510
		4801500		4802500
■ Input Circuit				
LED Indicate	YES	NO	YES	NO
Control Voltage Range	4-32 VDC		4-32 VDC	
Control Current	120mA Max.		120mA Max.	
Min. Turn-off Voltage	1.5 VDC		1.5 VDC	
Input Impedance	270Ω Min.		270Ω Min.	
■ Output Circuit				
Max. Load Current	15A (rms)		25A (rms)	
Nominal load Voltage (VAC)	440		440	
Load Voltage Range (VAC)	48-480		48-480	
Non-Repetitive Max. Peak Voltage (VAC)	800		800	
Non-Repetitive Max. Peak Current	200A		250A	
Max. Off-state Leakage Current	2mA		2mA	
Max. On-state Voltage Drop	1.6V		1.6V	
Min. Load Current	70mA		120mA	
Max. Off-state Slew Rated (dv/dt)	700V/μs		700V/μs	
Operating Frequency Range	47Hz ~ 63Hz		47Hz ~ 63Hz	
■ General Characteristics				
Zero-on or Random-on	Z		Z	
Max. Turn-on Time (60Hz)	8.3ms		8.3ms	
Max. Turn-off Time (60Hz)	8.3ms		8.3ms	
Insulation Resistance	DC 500V 10 ⁹ Ω Min. (Between Input & Output, Input / Output & Case)			
Dielectric Strength	3.5K VAC (Between Input & Output)			
Capacitance	15pF Max. (Between Input & Output)			
Operating Temperature	-20°C ~ +75°C		-20°C ~ +75°C	
Storage Temperature	-40°C ~ +100°C		-40°C ~ +100°C	
Heat Sink	2.1°C/W (Max. Load Current)		1.0°C/W (Max. Load Current)	



■ SPECIFICATIONS (DC INPUT CONTROL)

◆ MAX. LOAD CURRENT: 40A(rms) 480V

Type	ESR500	ESR510
Description	4804000	4804000
■ Input Circuit		
LED Indicate	YES	NO
Control Voltage Range	4-32 VDC	4-32 VDC
Control Current	120mA Max.	120mA Max.
Min. Turn-off Voltage	1.5 VDC	1.5 VDC
Input Impedance	270Ω Min.	270Ω Min.
■ Output Circuit		
Max. Load Current	40A (rms)	40A (rms)
Nominal load Voltage (VAC)	440	440
Load Voltage Range (VAC)	48-480	48-480
Non-Repetitive Max. Peak Voltage (VAC)	800	800
Non-Repetitive Max. Peak Current	400A	400A
Max. Off-state Leakage Current	2mA	2mA
Max. On-state Voltage Drop	1.8V	1.8V
Min. Load Current	120mA	120mA
Max. Off-state Slew Rated (dv/dt)	900V/μs	900V/μs
Operating Frequency Range	47Hz ~ 63Hz	47Hz ~ 63Hz
■ General Characteristics		
Zero-on or Random-on	Z	
Max. Turn-on Time (60Hz)	8.3ms	
Max. Turn-off Time (60Hz)	8.3ms	
Insulation Resistance	DC 500V 10 ⁹ Ω Min. (Between Input & Output, Input / Output & Case)	
Dielectric Strength	3.5K VAC (Between Input & Output)	
Capacitance	15pF Max. (Between Input & Output)	
Operating Temperature	-20°C ~ +75°C	
Storage Temperature	-40°C ~ +100°C	
Heat Sink	0.6°C/W (Max. Load Current)	



■ SPECIFICATIONS (AC INPUT CONTROL)

◆ MAX. LOAD CURRENT: 10A(rms), 120V/240V

Description \ Type	ESR520		ESR530	
	1201000	2401000	1201000	2401000
■ Input Circuit				
LED Indicate	YES		NO	
Control Voltage Range	50-280 VAC		50-280 VAC	
Control Current	15mA Max.		15mA Max.	
Min. Turn-off Voltage	40 VAC		35 VAC	
Input Impedance	106KΩ Min.		106KΩ Min.	
■ Output Circuit				
Max. Load Current	10A (rms)		10A (rms)	
Nominal load Voltage (VAC)	120	240	120	240
Load Voltage Range (VAC)	24-140	24-280	24-140	24-280
Non-Repetitive Max. Peak Voltage (VAC)	400	600	400	600
Non-Repetitive Max. Peak Current	125A		125A	
Max. Off-state Leakage Current	10mA		10mA	
Max. On-state Voltage Drop	1.6V		1.6V	
Min. Load Current	50mA		50mA	
Max. Off-state Slew Rated (dv/dt)	250V/μs		250V/μs	
Operating Frequency Range	47Hz ~ 63Hz		47Hz ~ 63Hz	
■ General Characteristics				
Zero-on or Random-on	Z			
Max. Turn-on Time (60Hz)	10ms			
Max. Turn-off Time (60Hz)	20ms			
Insulation Resistance	DC 500V 10 ⁹ Ω Min. (Between Input & Output, Input / Output & Case)			
Dielectric Strength	3.5K VAC (Between Input & Output)			
Capacitance	15pF Max. (Between Input & Output)			
Operating Temperature	-20°C ~ +80°C			
Storage Temperature	-40°C ~ +100°C			
Heat Sink	3.5°C/W (Max. Load Current)			



■ SPECIFICATIONS (AC INPUT CONTROL)

◆ MAX. LOAD CURRENT: 25A(rms) 120V/240V

Description \ Type	ESR520		ESR530	
	1202500	2402500	1202500	2402500
■ Input Circuit				
LED Indicate	YES		NO	
Control Voltage Range	50-280 VAC		50-280 VAC	
Control Current	15mA Max.		15mA Max.	
Min. Turn-off Voltage	40 VAC		35 VAC	
Input Impedance	106KΩ Min.		106KΩ Min.	
■ Output Circuit				
Max. Load Current	25A (rms)		25A (rms)	
Nominal load Voltage (VAC)	120	240	120	240
Load Voltage Range (VAC)	24-140	24-280	24-140	24-280
Non-Repetitive Max. Peak Voltage (VAC)	400	600	400	600
Non-Repetitive Max. Peak Current	260A		260A	
Max. Off-state Leakage Current	10mA		10mA	
Max. On-state Voltage Drop	1.6V		1.6V	
Min. Load Current	100mA		100mA	
Max. Off-state Slew Rated (dv/dt)	250 V/μs		250 V/μs	
Operating Frequency Range	47Hz ~ 63Hz		47Hz ~ 63Hz	
■ General Characteristics				
Zero-on or Random-on	Z			
Max. Turn-on Time (60Hz)	10ms			
Max. Turn-off Time (60Hz)	20ms			
Insulation Resistance	DC 500V 10 ⁹ Ω Min. (Between Input & Output, Input / Output & Case)			
Dielectric Strength	3.5K VAC (Between Input & Output)			
Capacitance	15pF Max. (Between Input & Output)			
Operating Temperature	-20°C ~ +80°C			
Storage Temperature	-40°C ~ +100°C			
Heat Sink	1.5°C/W (Max. Load Current)			



■ SPECIFICATIONS (AC INPUT CONTROL)

◆ MAX. LOAD CURRENT: 40A(rms), 120V/240V

Description \ Type	ESR520		ESR530	
	1204000	2404000	1204000	2404000
■ Input Circuit				
LED Indicate	YES		NO	
Control Voltage Range	50-280 VAC		50-280 VAC	
Control Current	15mA Max.		15mA Max.	
Min. Turn-off Voltage	40 VAC		35 VAC	
Input Impedance	106KΩ Min.		106KΩ Min.	
■ Output Circuit				
Max. Load Current	40A (rms)		40A (rms)	
Nominal load Voltage (VAC)	120	240	120	240
Load Voltage Range (VAC)	24-140	24-280	24-140	24-280
Non-Repetitive Max. Peak Voltage (VAC)	400	600	400	600
Non-Repetitive Max. Peak Current	315A		315A	
Max. Off-state Leakage Current	10mA		10mA	
Max. On-state Voltage Drop	1.8V		1.8V	
Min. Load Current	100mA		100mA	
Max. Off-state Slew Rated (dv/dt)	250 V/μs		250 V/μs	
Operating Frequency Range	47Hz ~ 63Hz		47Hz ~ 63Hz	
■ General Characteristics				
Zero-on or Random-on	Z			
Max. Turn-on Time (60Hz)	10ms			
Max. Turn-off Time (60Hz)	20ms			
Insulation Resistance	DC 500V 10 ⁹ Ω Min. (Between Input & Output, Input / Output & Case)			
Dielectric Strength	3.5K VAC (Between Input & Output)			
Capacitance	15pF Max. (Between Input & Output)			
Operating Temperature	-20°C ~ +75°C			
Storage Temperature	-40°C ~ +100°C			
Heat Sink	0.8°C/W (Max. Load Current)			