

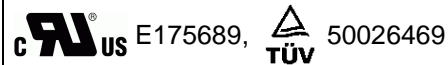

ECE —
The Name You Can Trust!

RADIAL LEADED PTC HX/HU MODEL



■ FEATURES

- Low hold current, Solid state
- Radial-leaded product ideal for up to 60V/600V
- Operation current: 0.08A~0.18A
- Maximum voltage: 60V/250V/600V
- Temperature range: -40°C to 85°C
- Cured, flame retardant epoxy polymer insulating material meets UL 94V-0 requirement
- Bulk packing, tape and reel available on most models

■ APPLICATIONS

- Network Equipment
- Customer Premise Equipment
- Modem / Information Technology Equipment
- Satellite Receivers

■ PART NUMBERING SYSTEM

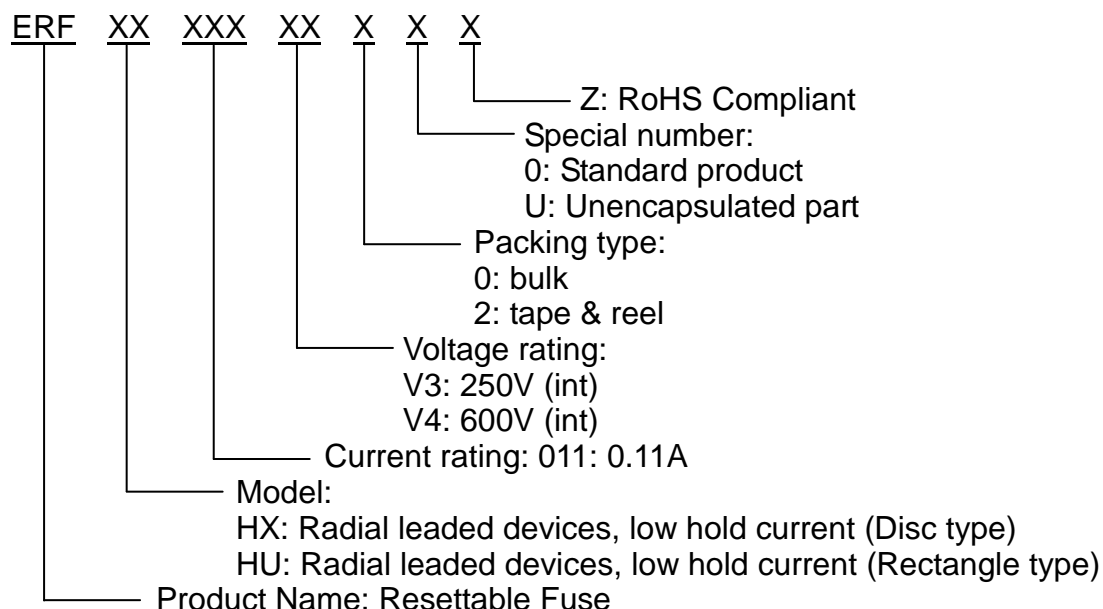

■ Marking system

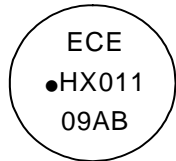

Example

*HU015-V4 Marking: HU015V4

*HU016-V4 Marking: HU016V4

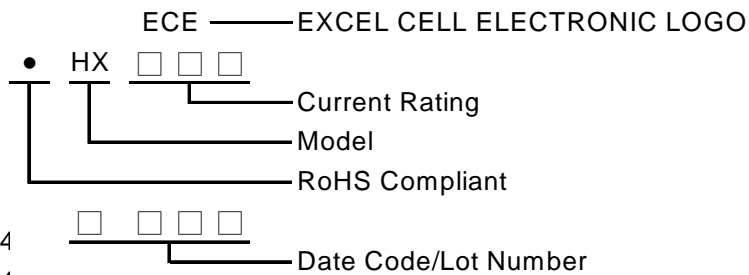

■ Electrical characteristics(23°C)

Part Number	Hold Current I_H, A	Maximum Current I_{MAX}, Amp	Max Oper. Voltage V_{MAX}, V_{dc}	Max Int. Voltage V_{I-MAX}, V_{dc}	Resistance Tolerance	
					R_{MIN} Ω	R_{1MAX} Ω
HX008-V3 U	0.08	3.0	60	250	14.0	33.0
HX008-V3	0.08	3.0	60	250	14.0	33.0
HX011-V3 U	0.11	3.0	60	250	5.0	16.0
HX011-V3	0.11	3.0	60	250	5.0	16.0
HU012-V3 U	0.12	3.0	60	250	6.0	16.0
HU012-V3	0.12	3.0	60	250	6.0	16.0
HU015-V3 U	0.15	3.0	60	250	3.0	12.0
HU015-V3	0.15	3.0	60	250	3.0	12.0
HU018-V3 U	0.18	10.0	60	250	0.8	4.0
HU018-V3	0.18	10.0	60	250	0.8	4.0
HU015-V4	0.15	3.0	60	600	6.0	22.0
HU016-V4	0.16	3.0	60	600	4.0	18.0

I_H =Hold current-maximum current at which the device will not trip at 23°C still air.

I_T =Trip current-minimum current at which the device will always trip at 23°C still air.

V_{MAX} =Maximum voltage device can withstand without damage at its rated current.

I_{MAX} = Maximum fault current device can withstand without damage at rated voltage (V max).

P_d =Typical power dissipated from device when in the tripped state in 23°C still air environment.

R_{MIN} =Minimum device resistance at 23°C.

R_{1MAX} =Maximum device resistance at 23°C 1 hour after tripping.



ECE —
The Name You Can Trust!

■ Typical Time-To-Trip at 23°C

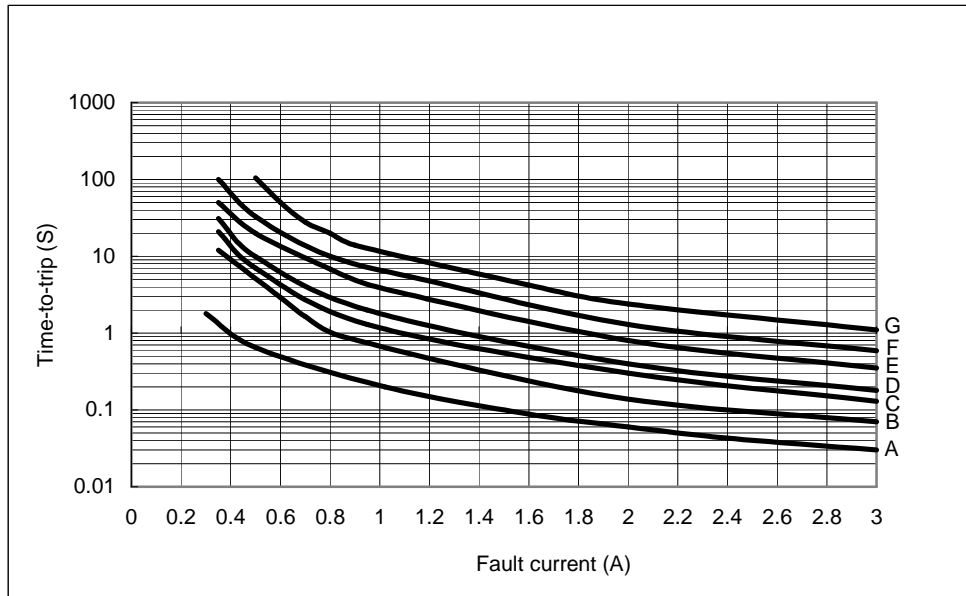

A=HX008-V3(U)
B=HX011-V3(U)
C=HU012-V3(U)
D=HU015-V3(U)
E=HU018-V3(U)
F=HU015-V4
G=HU016-V4

NOTE: ALL HX/ HU products are designed to assist equipment to pass ITU, UL1950 or GR1089 specification.

CAUTION: HX/ HU devices are not intended for continuous use of Line Voltage such as 120VAC and above.

■ Thermal Derating Curve

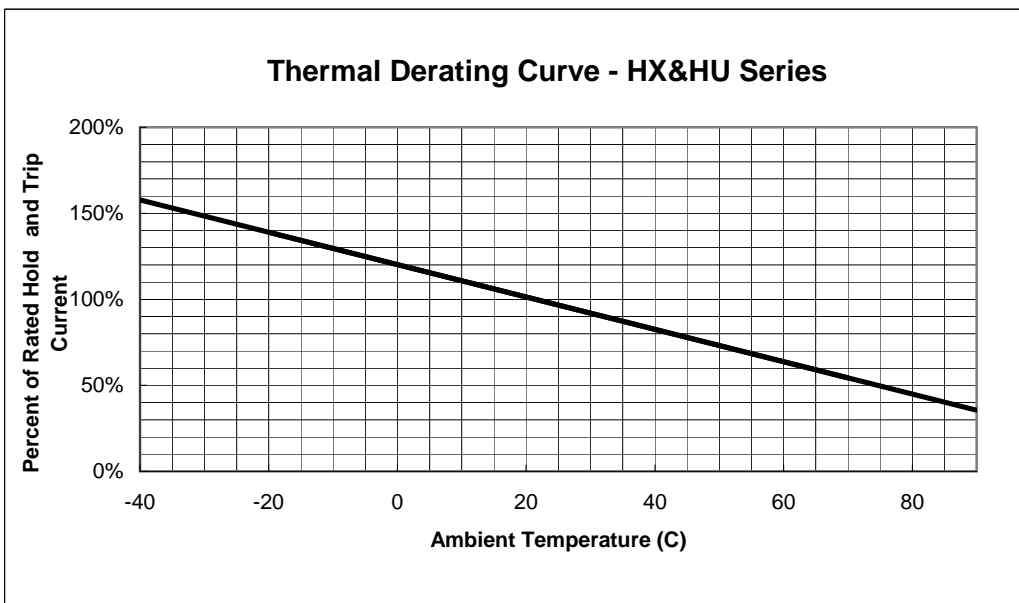

■ HX/HU Product Dimensions (UNIT: mm)

Part Number	Figure	A	B	C	D	E
		Maximum	Maximum	Typical	Minimum	Maximum
HX008-V3 U	1	5.1	9.1	5.0	4.7	3.8
HX008-V3	1	5.8	9.6	5.0	4.7	4.6
HX011-V3 U	1	5.9	9.4	5.0	4.7	3.8
HX011-V3	1	6.8	9.9	5.0	4.7	4.6
HU012-V3 U	2	6.0	10.0	5.0	4.7	3.8
HU012-V3	2	6.5	11.0	5.0	4.7	4.6
HU015V3 U	2	6.0	10.0	5.0	4.7	3.8
HU015V3	2	6.5	11.0	5.0	4.7	4.6
HU018-V3 U	2	10.4	12.6	5.0	4.7	3.8
HU018-V3	2	10.9	12.6	5.0	4.7	4.6
HU015-V4	2	13.5	12.6	5.0	4.7	6.0
HU016-V4	2	16.0	12.6	5.0	4.7	6.0

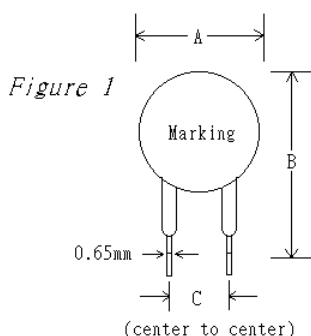

HX Model

- Lead Size: 22AWG
- φ0.65mm Diameter

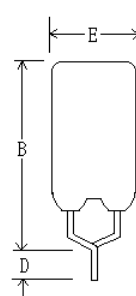

HU Model

- Lead Size: 22AWG
- φ0.65mm Diameter

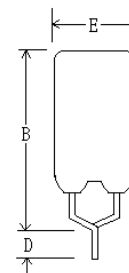
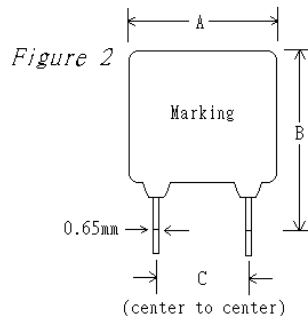

■ Standard Package for Reference

P/N	Pcs/Bag	Reel/Tape	P/N	Pcs/Bag	Reel/Tape
HX008-V3U	300	1.5K	HU015-V3U	300	1.5K
HX008-V3	300	1.5K	HU015-V3	300	1.5K
HX011-V3U	300	1.5K	HU018-V3U	200	1.2K
HX011-V3	300	1.5K	HU018-V3	200	1.2K
HU012-V3U	300	1.5K	HU015-V4	100	600
HU012-V3	300	1.5K	HU016-V4	100	600