

## SMAT SERIES



The SMAT transducers are specifically developed to meet various requirements, such as loud sound pressure level, mounting methods, connection possibilities and dimensions. The transducers do not have a built-in oscillator. The drive frequency must be generated with electronics outside the transducer. Recommended drive circuits are described in this catalogue. Our transducers produce a highly reliable audible tone signal, giving either an extremely clear and penetrating tone or a soft sound for non-aggressive signals. They are available in five sizes: 13mm, 17mm, 21mm, 24mm and 30mm.

## ADVANTAGES & APPLICATIONS

### ADVANTAGES :

- Octagonal form
- Models with different pin pitches
- Light but solid construction
- Not fixed working frequency
- Easily mountable
- SMAT-13 and SMAT-17 for limited space applications
- SMD models with heat resistant labels for protection during re-flow soldering
- Automatic pick & place

### APPLICATIONS :

- Alarms
- Gas & metal detectors
- Measuring & weighing equipment
- Medical instrumentation
- Timers & clocks
- Instrumentation & control systems
- Copiers
- Automobiles & trucks
- Games & toys
- Cash registers

## SPECIFICATIONS

Model	SPL * (dB(A))	Frequency Range (Hz)	Capacitance (+/-30%) nF)	Operating voltage (VAC pp)	Weight (g)
SMAT-13	See graph	800-5000	7.8	0 to 30	1
SMAT-17	See graph	800-5000	17.5	0 to 30	2
SMAT-21	See graph	600-5000	12.4	0 to 30	2.5
SMAT-24	See graph	400-5000	18.6	0 to 30	4
SMAT-30	See graph	300-5000	25	0 to 30	5

Operating temperature	-20°C to +70°C
Storage temperature	-40°C to +85°C
Life time (@ 21°C)	@12Vpp continuous use at resonance frequency, tested on maximum sound pressure (eg. SMAT-21 @ 3.75 kHz). Life expectations: min.1000 hours. All tests are made @ 20°C mounted on PCB (expected life time curve in addendum).
Case material	ABS (UL rating: 94 HB) for pin-versions, SMAT-13/21/30 PBT (UL rating: 94 HB) for pin versions, SMAT-17/24 PPS (UL rating: 94 V0/5V) for SMD-versions, SMAT-13/17/21/24/30
Standard colour of case	Grey

\* All measurements are made in free air @ 21°C @ 30 cm @10 Vpp (square wave). The test buzzer is soldered on a pcb board with dimensions of 24 cm x 11 cm.

## ELECTRICAL PARAMETERS

<p><b>Model</b></p> <p>Sound pressure vs. frequency</p>	<p><b>SMAT-13</b></p> <p><b>dB (A)</b></p> <p><b>kHz</b></p>	<p><b>SMAT-17</b></p> <p><b>dB (A)</b></p> <p><b>kHz</b></p>
<p><b>Model</b></p> <p>Sound pressure vs. frequency</p>	<p><b>SMAT-21</b></p> <p><b>dB (A)</b></p> <p><b>kHz</b></p>	<p><b>SMAT-24</b></p> <p><b>dB (A)</b></p> <p><b>kHz</b></p>
<p><b>Model</b></p> <p>Sound pressure vs. frequency</p>	<p><b>SMAT-30</b></p> <p><b>dB (A)</b></p> <p><b>kHz</b></p>	<p><b>Peak hold frequency sweep from 1 to 8kHz with a square wave signal of 10Vpp. (precision of frequency: +/- 15%)</b></p>

All measurements are made @ 30 cm in free air @ 21°C.

## DRIVE CIRCUITS (typical circuits)

### IC Oscillation Circuit

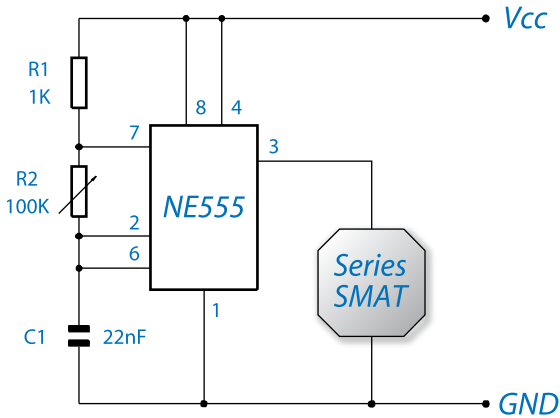

### Multivibrator Circuit

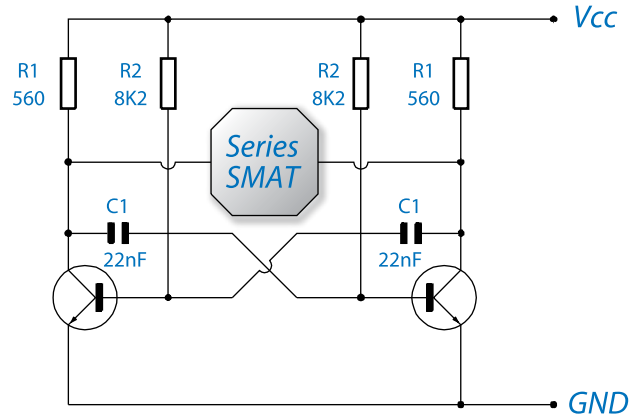

### Inverter Oscillator

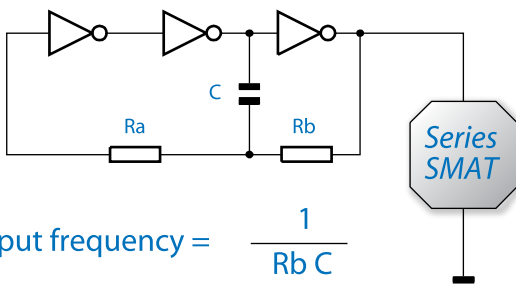

$$\text{Output frequency} = \frac{1}{R_b C}$$

Inverters are CMOS 4049 or 4069

### Nandgate Oscillator

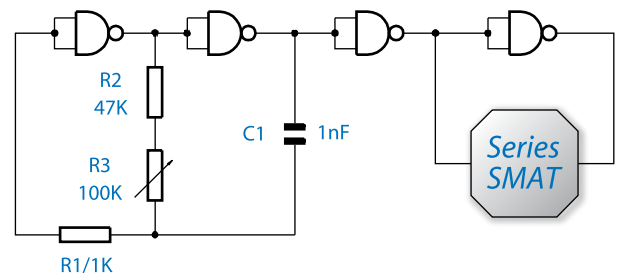

Nandgates are CMOS 4011A

### 5 Nandgate Oscillator - 3 tones

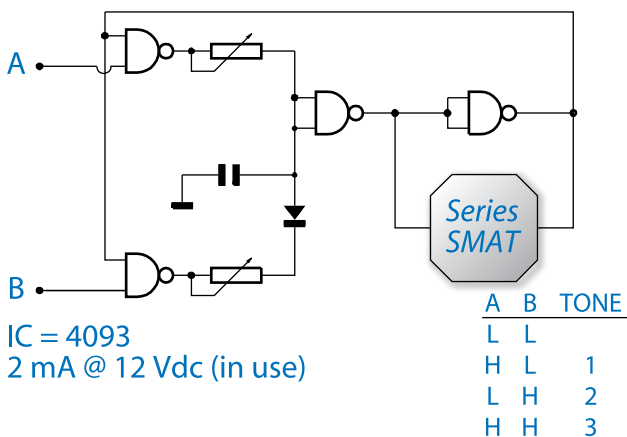

### Tone Generator - CMOS - Gate Multifunction

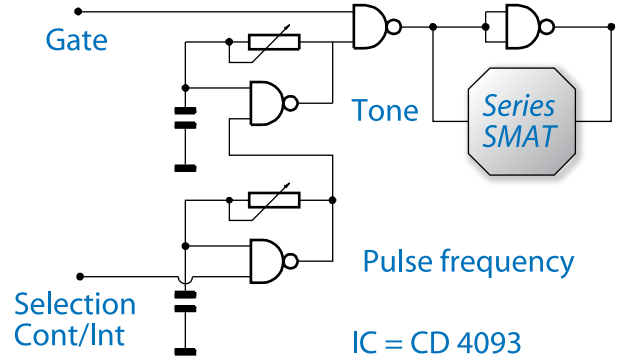

When the transducers are used in a drive circuit at one single frequency, the designer should bear in mind that the precision of the frequency, as mentioned on the graph "sound pressure vs. Frequency" is +/- 15%. We therefore recommend to test the sound pressure level with the transducer connected to the final drive circuit.

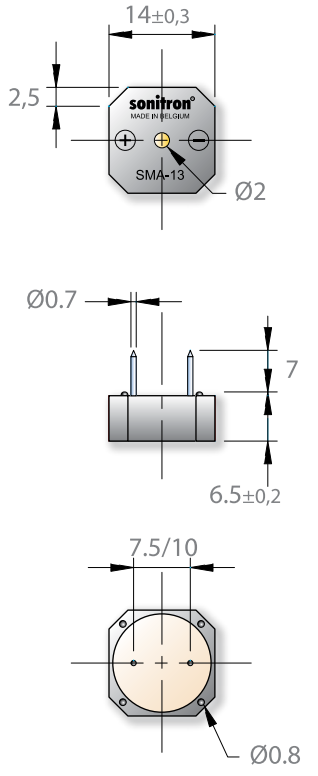
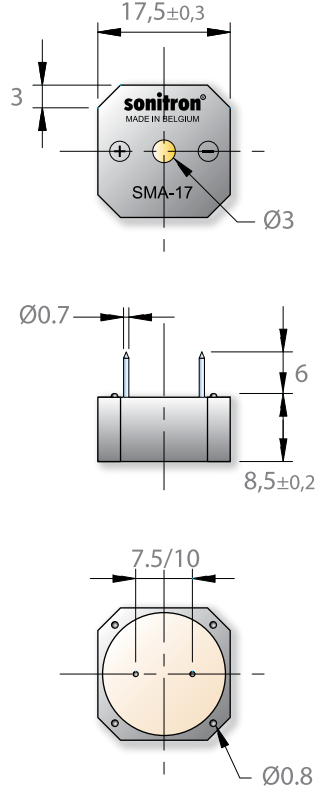
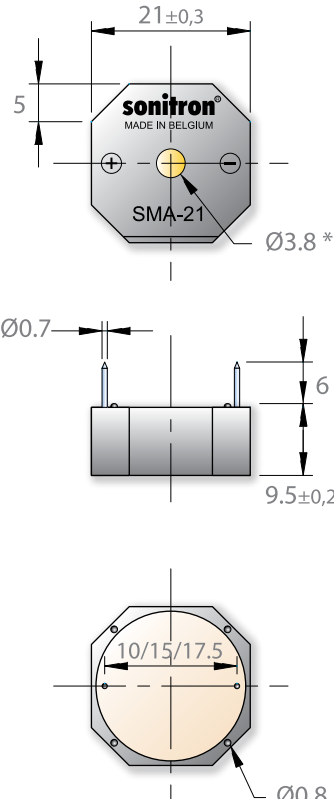
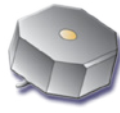
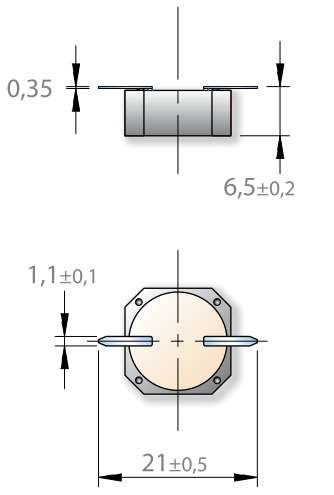
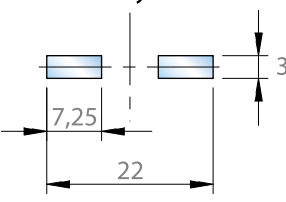
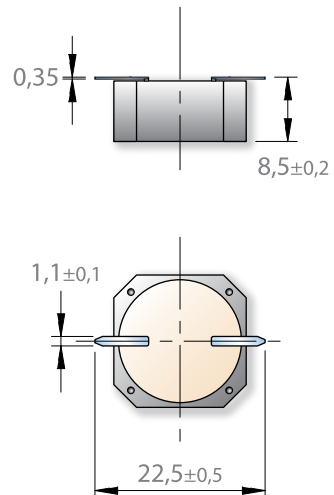
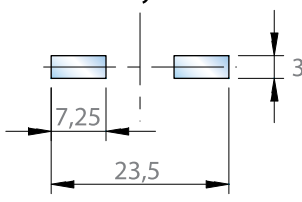
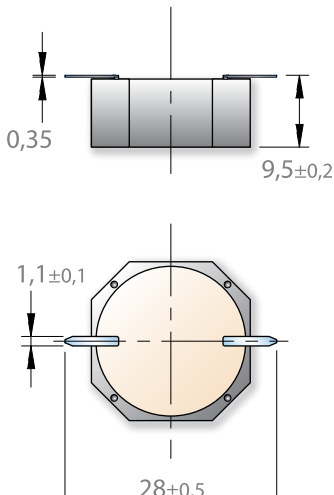
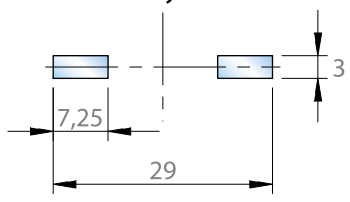

**DIMENSIONS SMA & SMAT-SERIES** (All dimensions are in mm)

<p><b>Pin version</b></p> 	<p><b>SMA(T)-13</b></p> 	<p><b>SMA(T)-17</b></p> 	<p><b>SMA(T)-21</b></p> 
<p><b>SMD version</b></p> 	 <p><b>Recommended PCB lay-out</b></p> 	 <p><b>Recommended PCB lay-out</b></p> 	 <p><b>Recommended PCB lay-out</b></p> 

\* The sound hole of SMA-21 LV has a diameter of 3 mm, whereas the other SMA-21 types have a 3,8 mm sound hole.

(All dimensions are in mm)

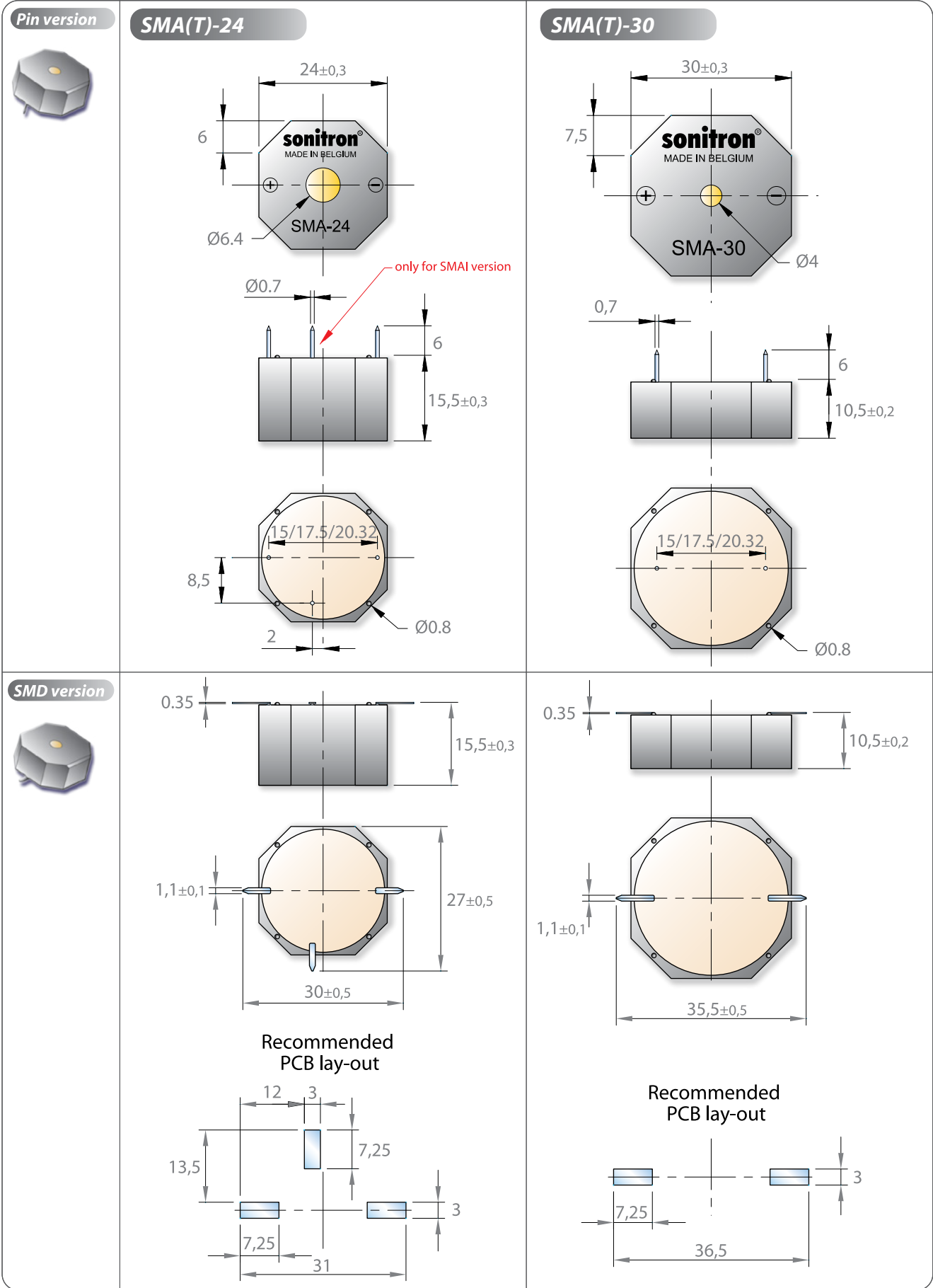

## MOUNTING POSSIBILITIES FOR THE SMA & SMAT SERIES

Soldered with pins on the PCB

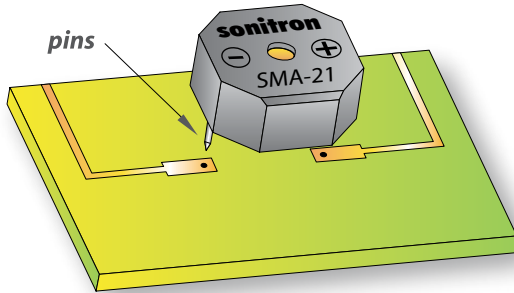

SMD soldered on the PCB

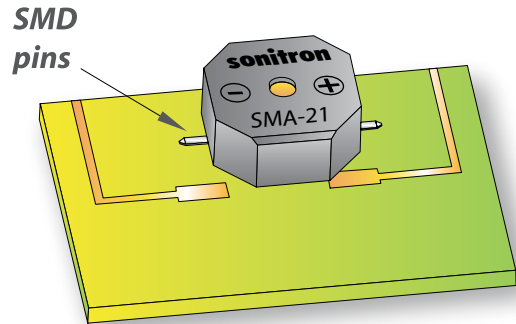

## PRODUCT OPTIONS SMA & SMAT SERIES

Option Code	example	Description
<b>SP01</b>	SMAT-21-P10/SP01	Contains heavy duty wires (plastic insulation) <i>(only for SMA(T)-21 and SMA(T)-24)</i>
<b>SP02</b>	SMAT-21-P17.5/SP02	Contains heavy duty wires (plastic insulation), connection sealed with silicone <i>(only for SMA(T)-21, SMA(T)-24)</i>
<b>SP04</b>	SMA-13LC-S/SP04	The PCB of the buzzer/transducer is secured with epoxy-adhesive
<b>SP05</b>	SMA-24L-P17.5/SP05	Extended frequency control (only SMA series)
<b>Wash Tab</b>	SMAT-13-P7.5 +Wash Tab	Recommended for automatic washing production process. The PCB is secured with epoxy-adhesive+ wash tab upon the sound-emitting hole, avoiding liquid penetration into the cavity. <b>TO BE REMOVED AFTER the washing process for good sound output!!!</b>
<b>MC</b>	SMAT-13-P10-MC	Acryl coating (Membrane Coating). Recommended for aggressive, humid or smoggy environment.
<b>FP13 FP13SR</b> <b>FP17 FP17SR</b> <b>FP21 FP24</b> <b>FP30</b>		7 different Foam Patches are available to cover the SMA(T) series for extra acoustic and mechanical stabilization. See page 38, 39

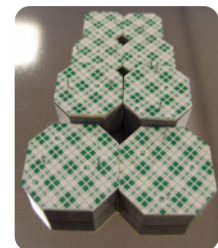

**To order an option add the suffix to the model number of the SMA(T)-series.**

**Capton** A heat protection label standard for all SMD buzzers, in capton material glued on the SMD model of the SMA(T) buzzer. This enables the user to pick up the buzzer by vacuum.  
During the re-flow soldering process the heat shield label remains on the buzzer and must be removed after soldering.

## PACKAGING SMA & SMAT-SERIES

All models with pin terminals are put on a polystyrene board (245 L x 245 W) and sold in boxes with dimensions 250 L x 250 W x 125 H.

Number	SMA(T)-13 series	SMA(T)-17 series	SMA(T)-21 series	SMA(T)-24 series	SMA(T)-30 series
per board	250	150	100	100	64
per box	(8x250) 2000	(6x150) 900	(5x100) 500	(5x100) 500	(6x64) 384

All SMD models are packed in trays (245 L x 245 W) and sold in boxes with dimensions 250 L x 250 W x 125 H.

Number	SMA(T)-13 S	SMA(T)-17 S	SMA(T)-21 S	SMA(T)-24 S	SMA(T)-30 S
per board	100	81	49	42	25
per box	(9x100) 900	(8x81) 648	(7x49) 343	(5x42) 210	(6x25) 150

Dimensions of the tray and position of the SMD components:

Model	A	B
SMA(T)-13-series	22 mm	16 mm
SMA(T)-17-series	24 mm	18 mm
SMA(T)-21-series	30 mm	16.7 mm
SMA(T)-24-series	35 mm	22.6 mm
SMA(T)-30-series	36 mm	19 mm

