

## FYL-3004GD1D

### Features:

- ◆ General purpose leads
- ◆ RoHs compliant.

### Descriptions:

- ◆ Dice material: Gap
- ◆ Emitting Color: Green
- ◆ Device Outline: Φ3mm Round Type.
- ◆ Lens Type: Green diffused.

### Radiation pattern.

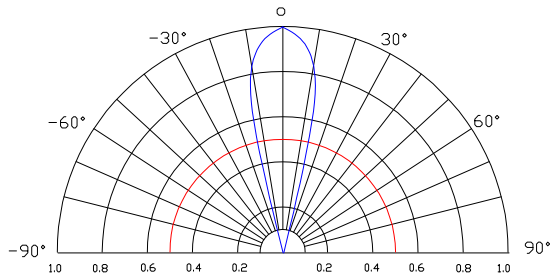

### Package configuration

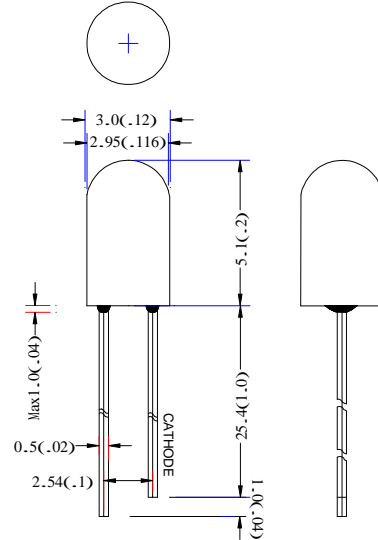

- ◆ All dimensions are millimeters (inches)
- ◆ Tolerance is  $\pm 0.25\text{mm}(.010\text{'})$  unless otherwise noted.

### Absolute maximum ratings( $T_a=25^\circ\text{C}$ )

Parameter	MAX.	Unit
Power Dissipation	50	mW
Peak Forward Current (1/10 Duty Cycle, 0.1ms Pulse Width)	100	mA
Continuous Forward Current	35	mA
Derating Linear From 50°C	0.4	mA/°C
Reverse Voltage	5	V
Electrostatic Discharge (ESD)	150	V
Operating Temperature Range	-30°C to +80°C	
Storage Temperature Range	-40°C to +100°C	
Lead Soldering Temperature [4mm(.157") From Body]	260°C for 5 Seconds	

### Electrical and optical characteristics( $T_a=25^\circ\text{C}$ )

Parameter	Symbol	Min.	Typ.	Max.	Unit	Test Condition
Luminous Intensity	$I_v$	-	50	-	mcd	$I_F=20\text{mA}$
Viewing Angle	$2\theta_{1/2}$	20	25	30	Deg	
Peak Emission Wavelength	$\lambda_p$	563	568	573	nm	
Domestic Wavelength	$\lambda_d$	565	570	575	nm	
Spectral Line Half-Width	$\Delta\lambda$	15	20	25	nm	
Forward Voltage	$V_F$	1.8	2.1	2.3	V	
Reverse Current	$I_R$			10	$\mu\text{A}$	$V_R=5\text{V}$

## Typical Electrical Characteristics Curves (25 °c Ambient Temperature Unless Otherwise Noted)

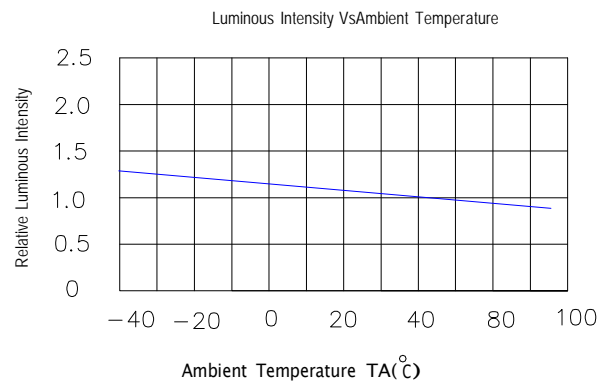
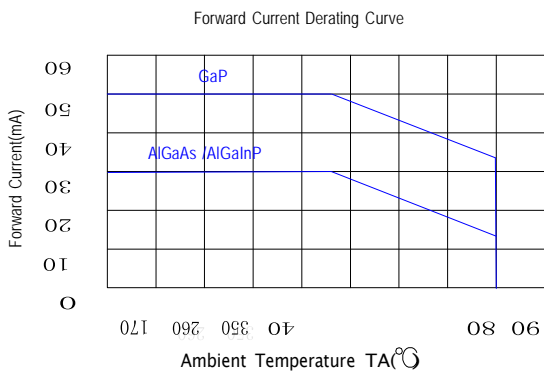
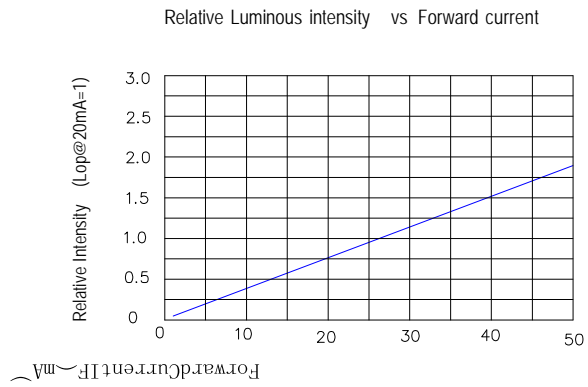
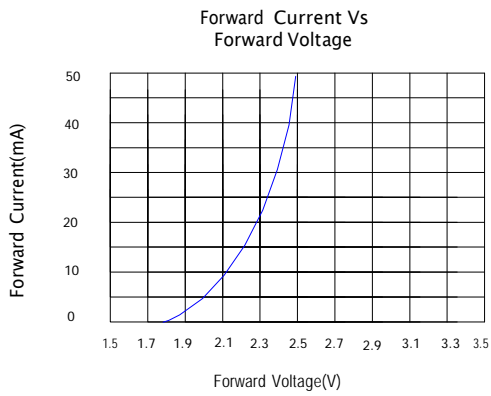
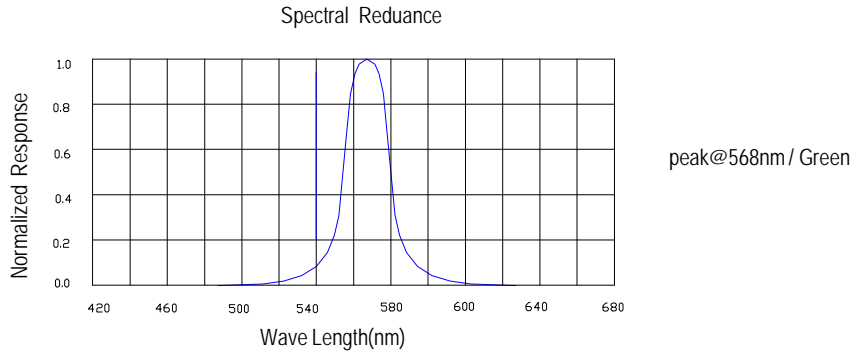

## LAMP PACKING.

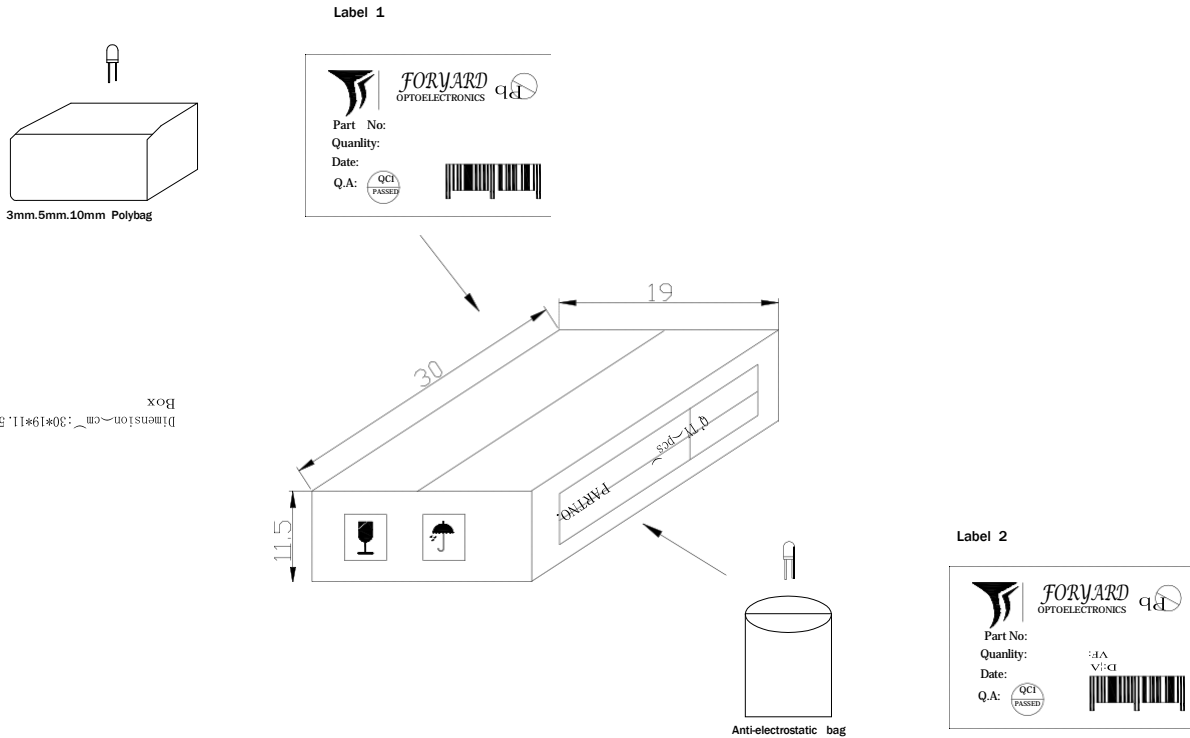

DEVICE	QTY/polybag(pcs)	Polybag/box A	Fig
5mm(T-1 3/4)	1000	8 bags	Label 1
3mm(T-1)	1000	10 bags	Label 1
10mm(T-1)	250	8 bags	Label 1
Blue/Green/White	500pcs	8 bags	Label 2

**CARTON**  
Dimension(cm):39\*32\*38

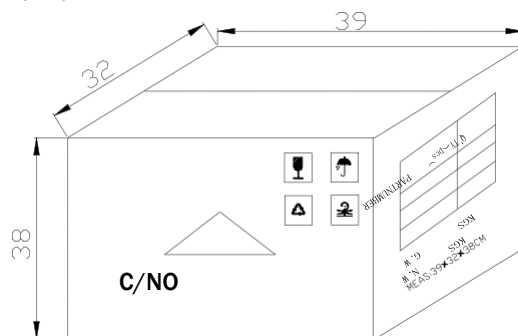

**6 Boxes/Carton**  
5mm:48,000pcs  
3mm:60,000pcs  
10mm:12,000pcs  
Blue/Pure Green/bluish Green  
/White:24,000pcs