

按钮开关

Push-Button Switch

型号(TYPE): PBS-15B

技术特性 (Specification)

- 规格 (Rating): 3A 125VAC; 1A 250VAC
- 接触电阻 (Contact R): 20mΩ max
- 绝缘电阻 (Insulation R): 500V DC 100MΩ min
- 耐电压 (Dielectric Strength): 1 Minute 1000V AC
- 操作温度 (Operating Temperature): -25°C ~ +85°C
- 电气寿命 (Electrical Life): 50,000 Cycles

外型图 (Outline Drawing)

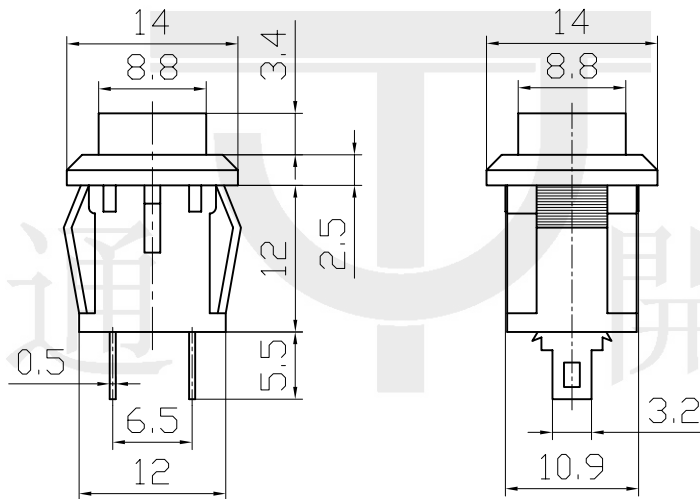

安装尺寸 (Mounting)

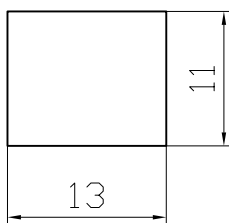

电路图 (Circuitry)

